

Where is My Data?
Data Flow Through the Hypervisor
TakeDownCon Dallas 2011

Edward L. Haletky
Virtualization Security Analyst
The Virtualization Practice
VMware vExpert



Top of Rack pSwitch

Chassis

pNIC

pNIC

USB
Serial
Parallel
Port

Layer 2 Stretch
pSwitch

Fabric
pSwitch

Storage Stretch
VPLEX

VPLEX

FC SAN

IP
Storage

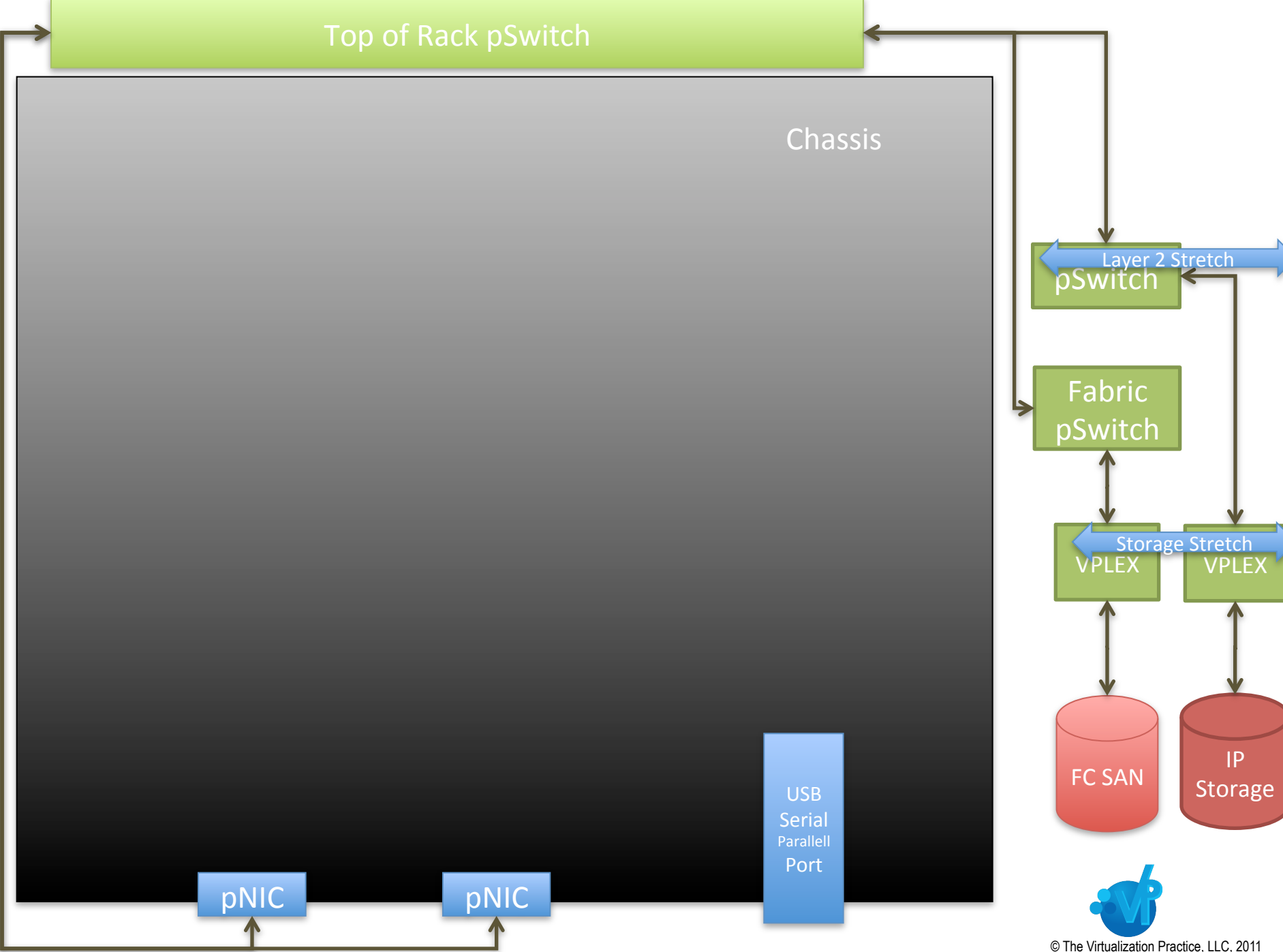

Top of Rack pSwitch

Chassis

pvNIC

pvNIC

pNIC

pNIC

USB
Serial
Parallel
Port

Layer 2 Stretch
pSwitch

Fabric
pSwitch

Storage Stretch
VPLEX

VPLEX

FC SAN

IP
Storage

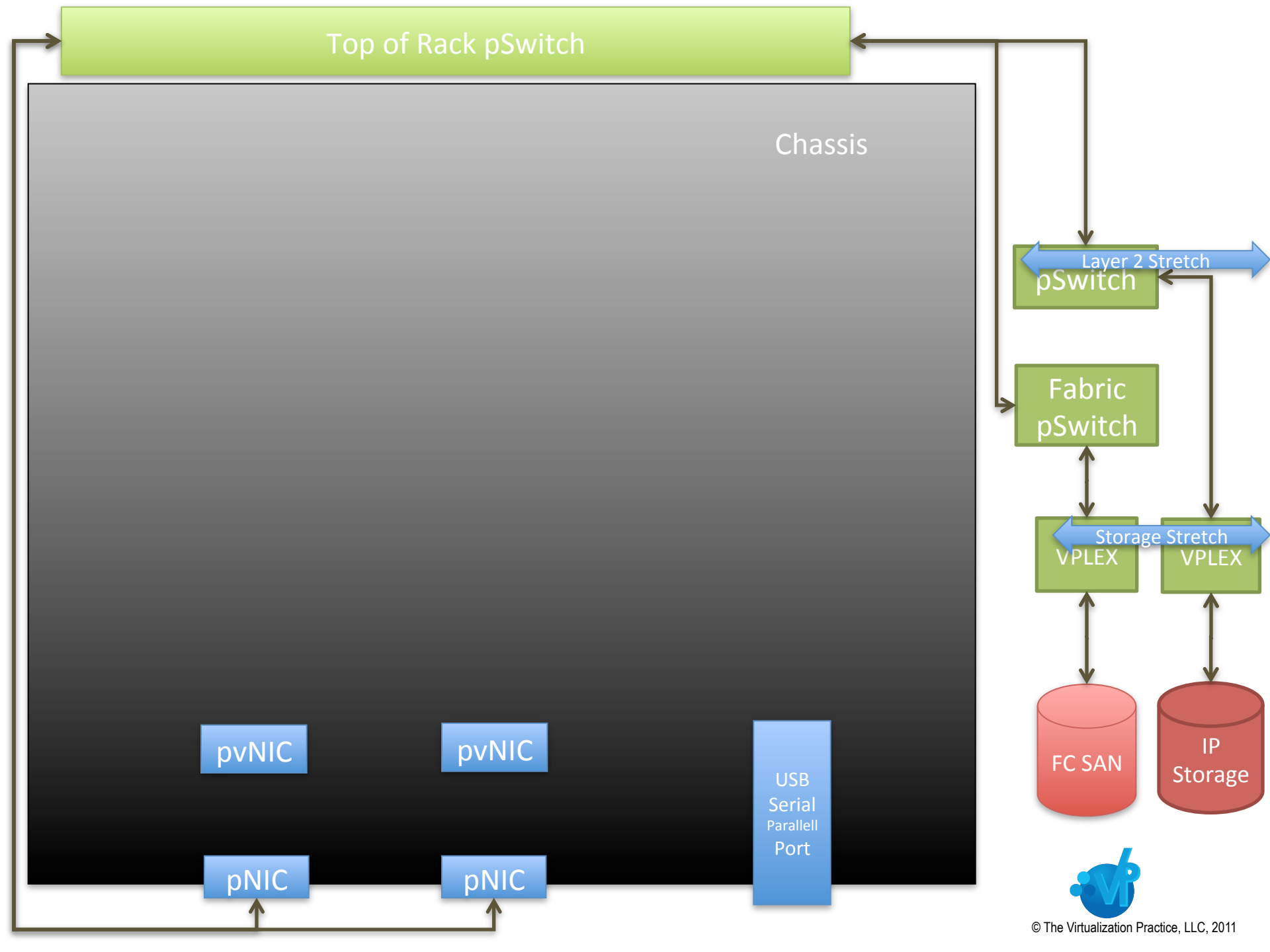

Top of Rack pSwitch

Chassis

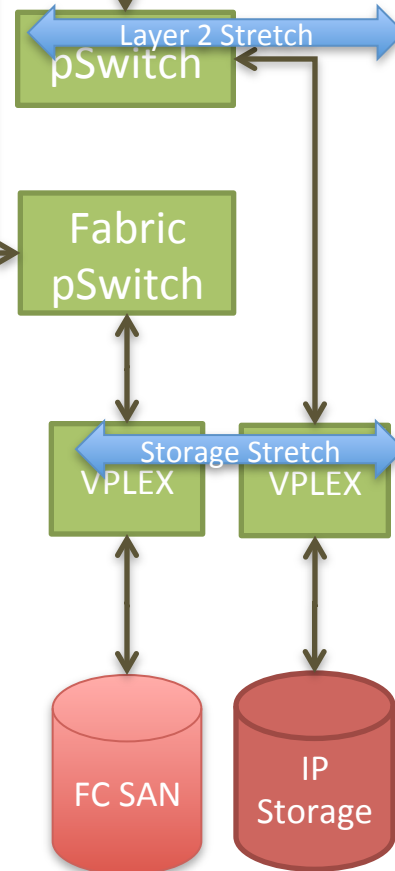
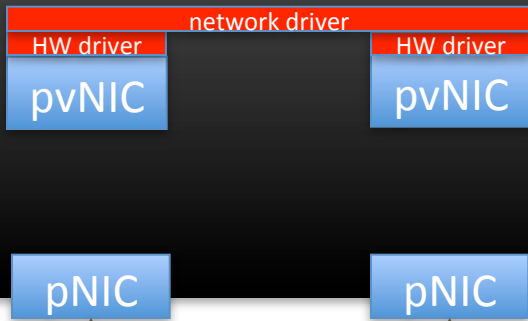

Top of Rack pSwitch

Chassis

Egress

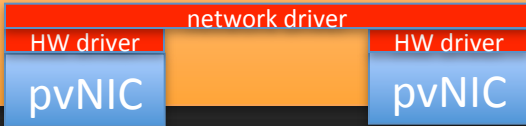

USB
Serial
Parallel
Port

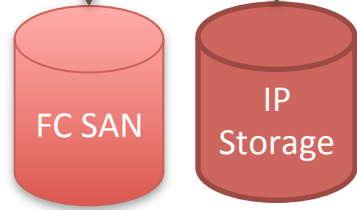

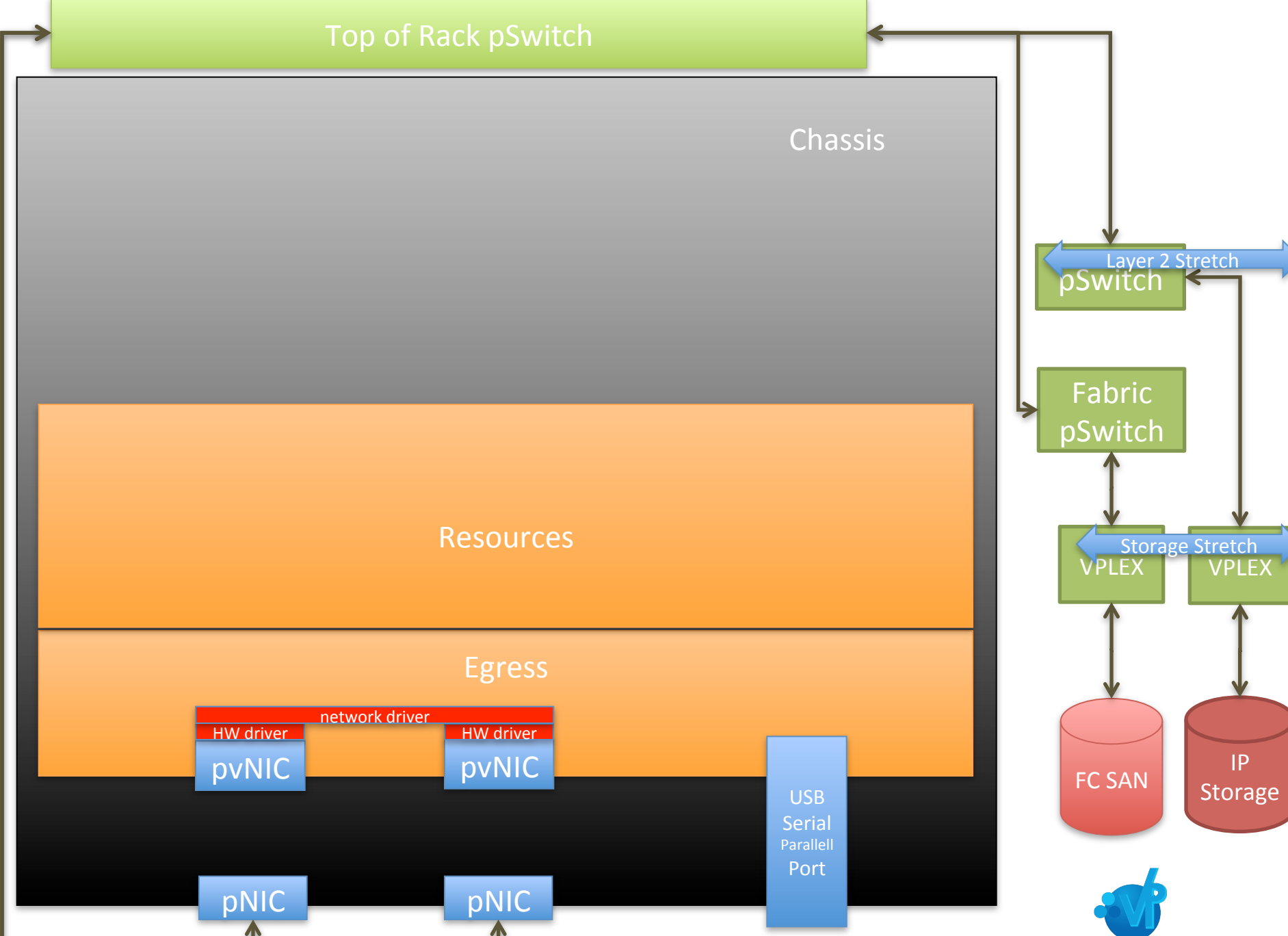

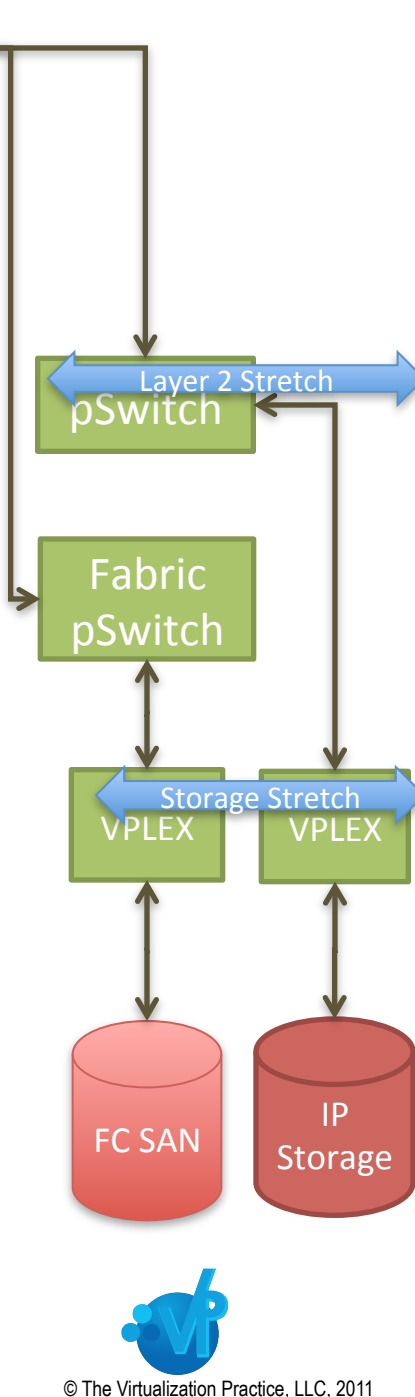
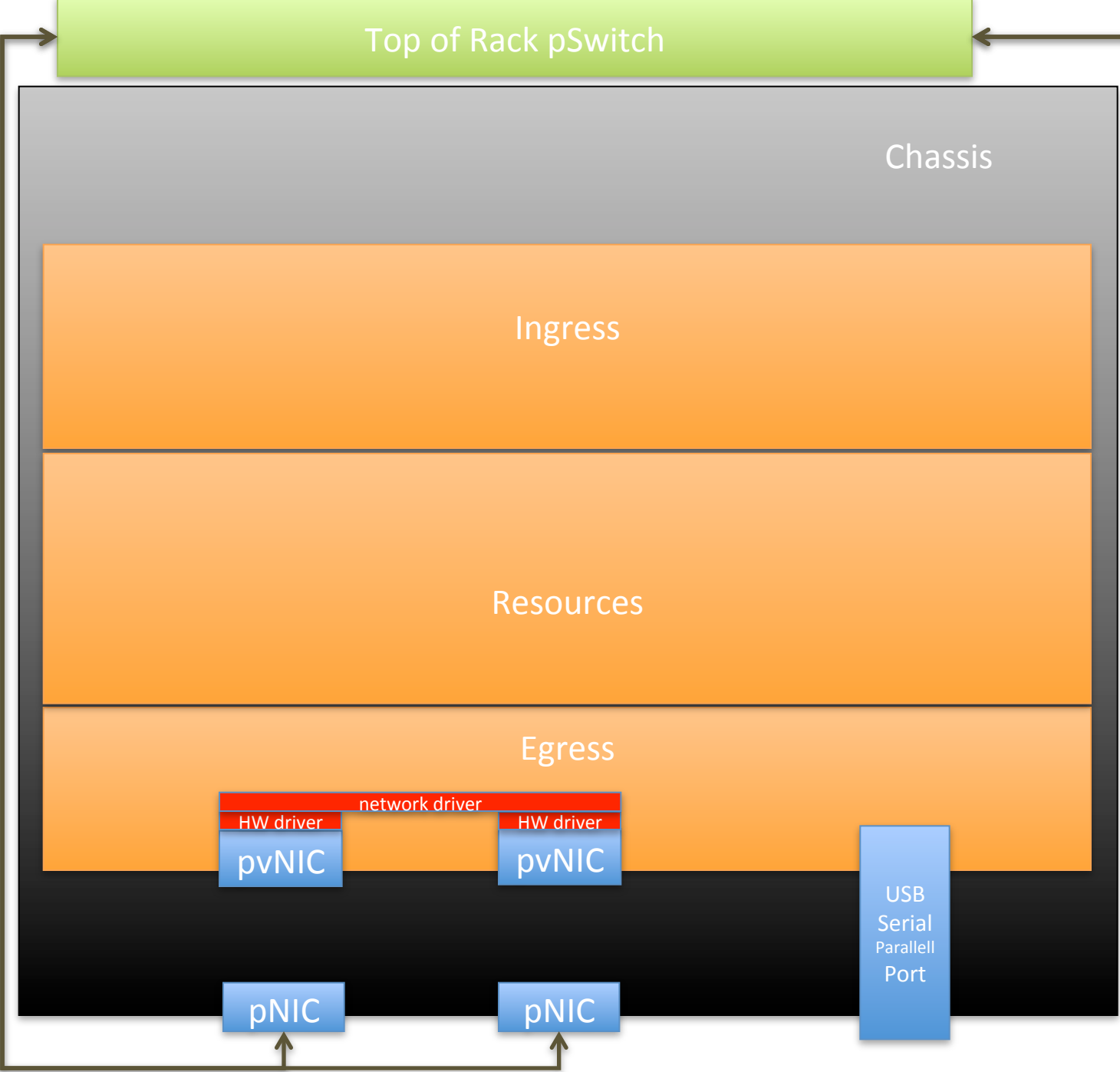

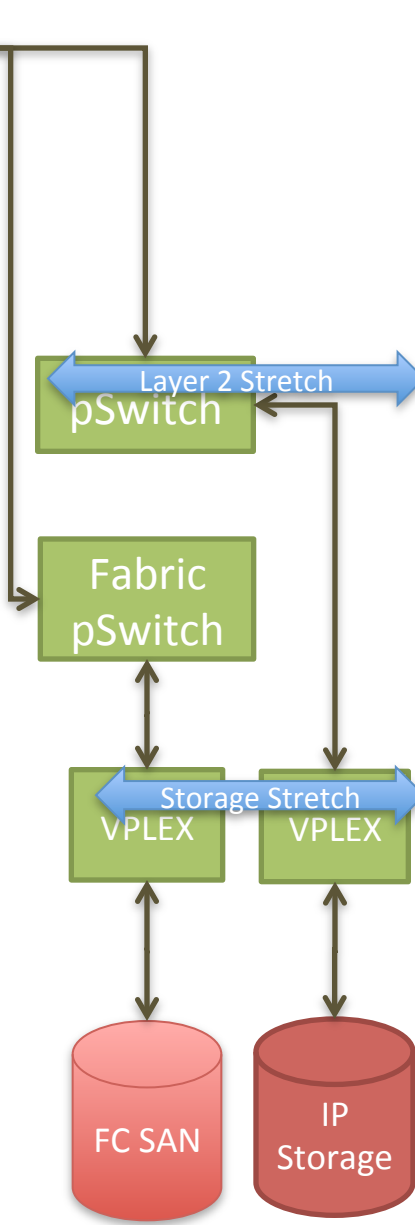
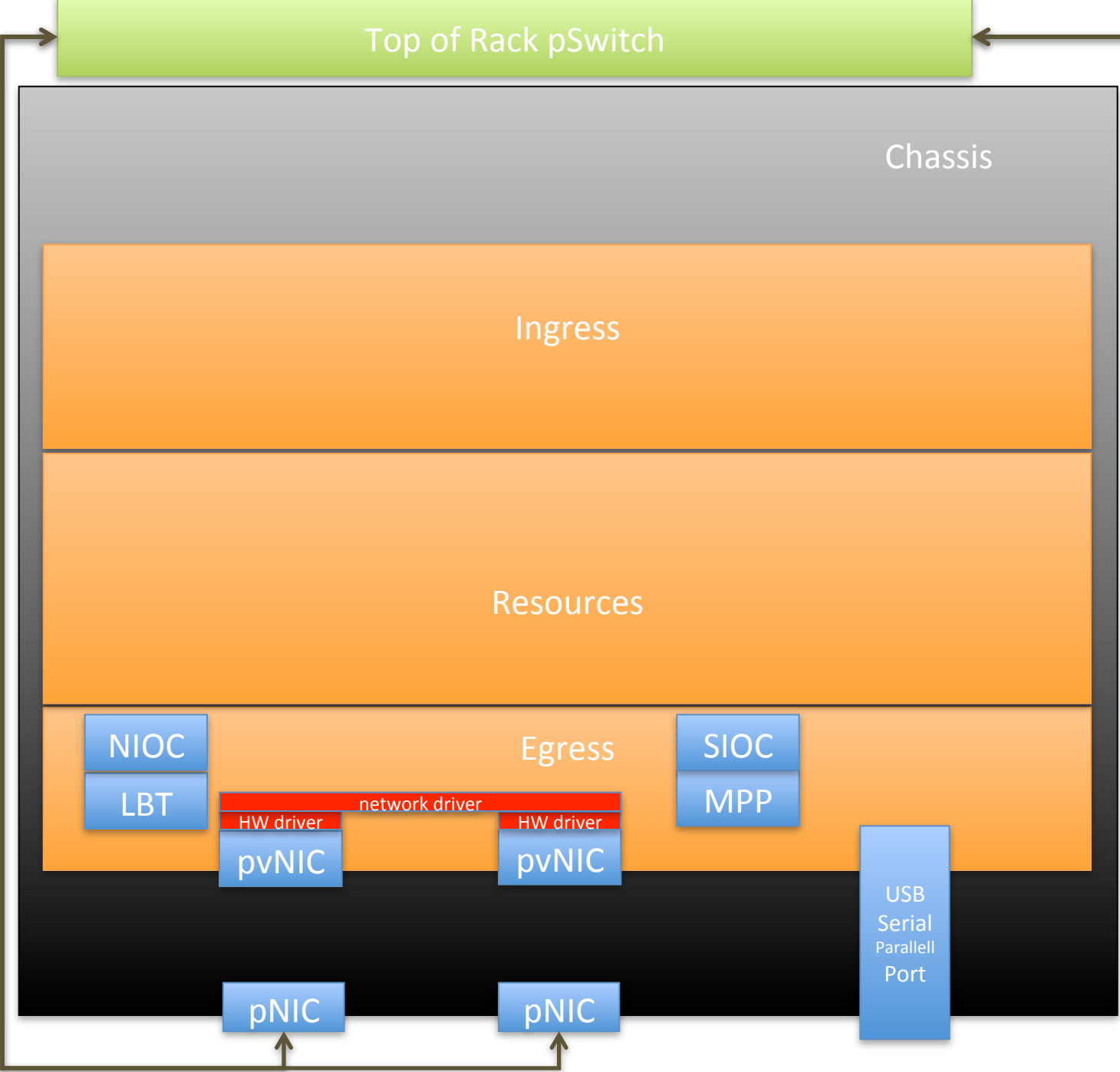

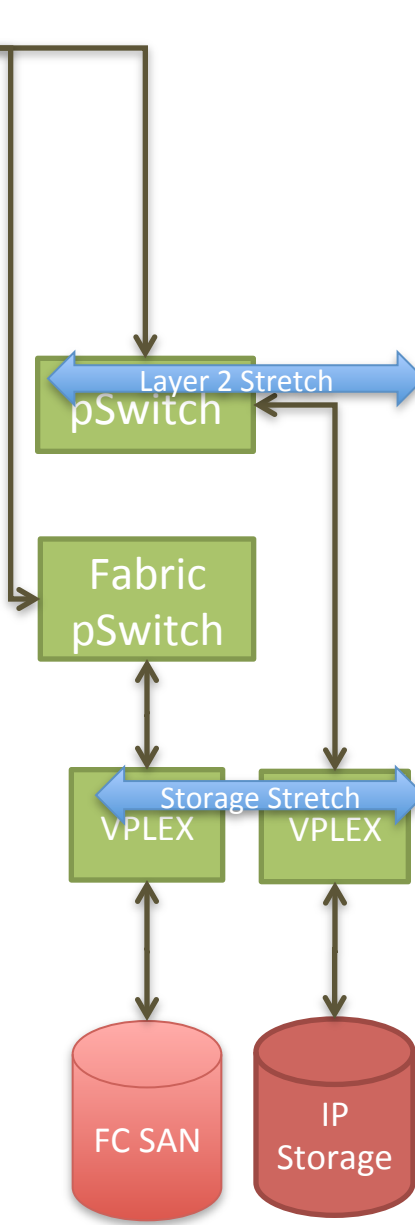
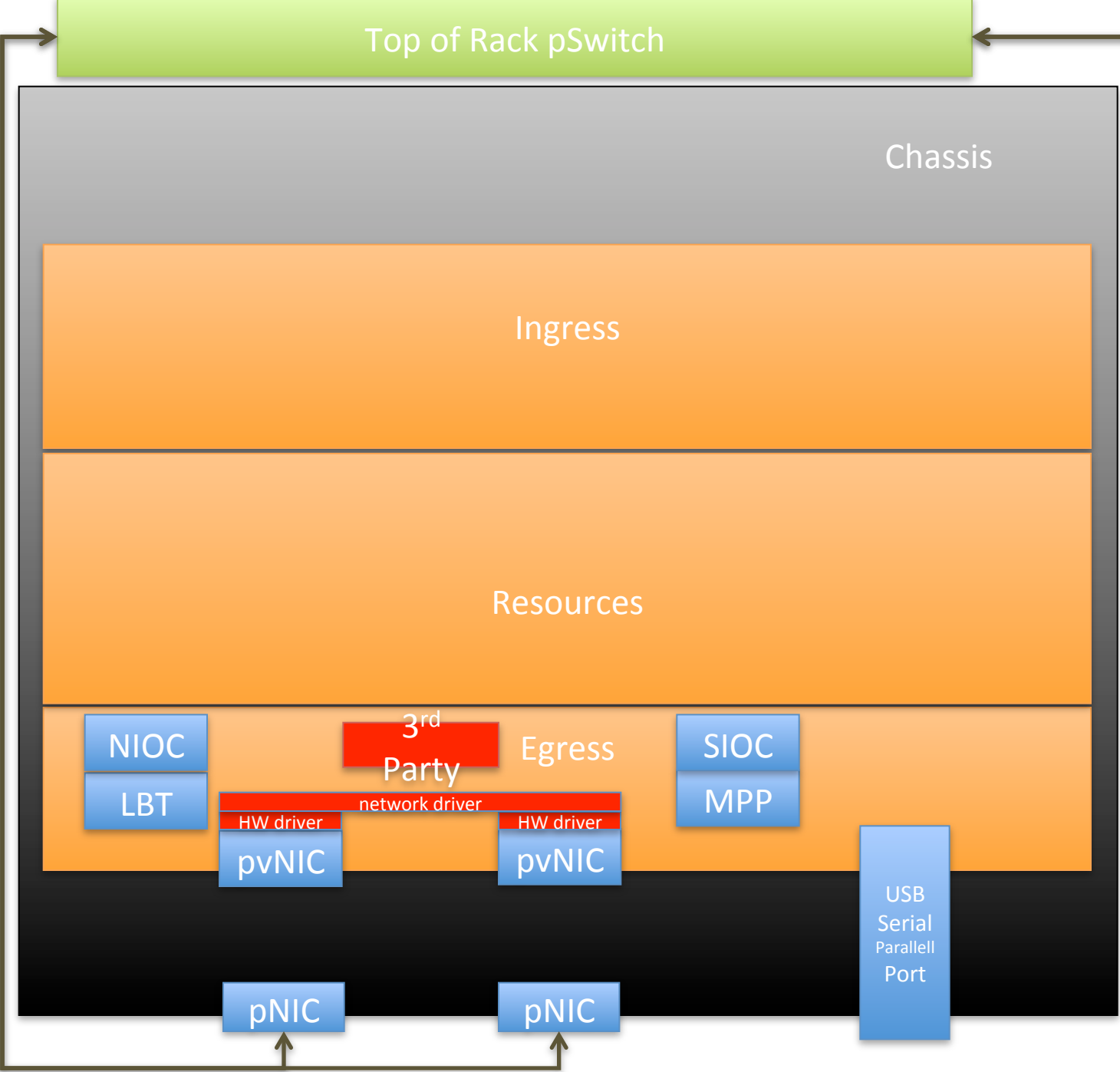

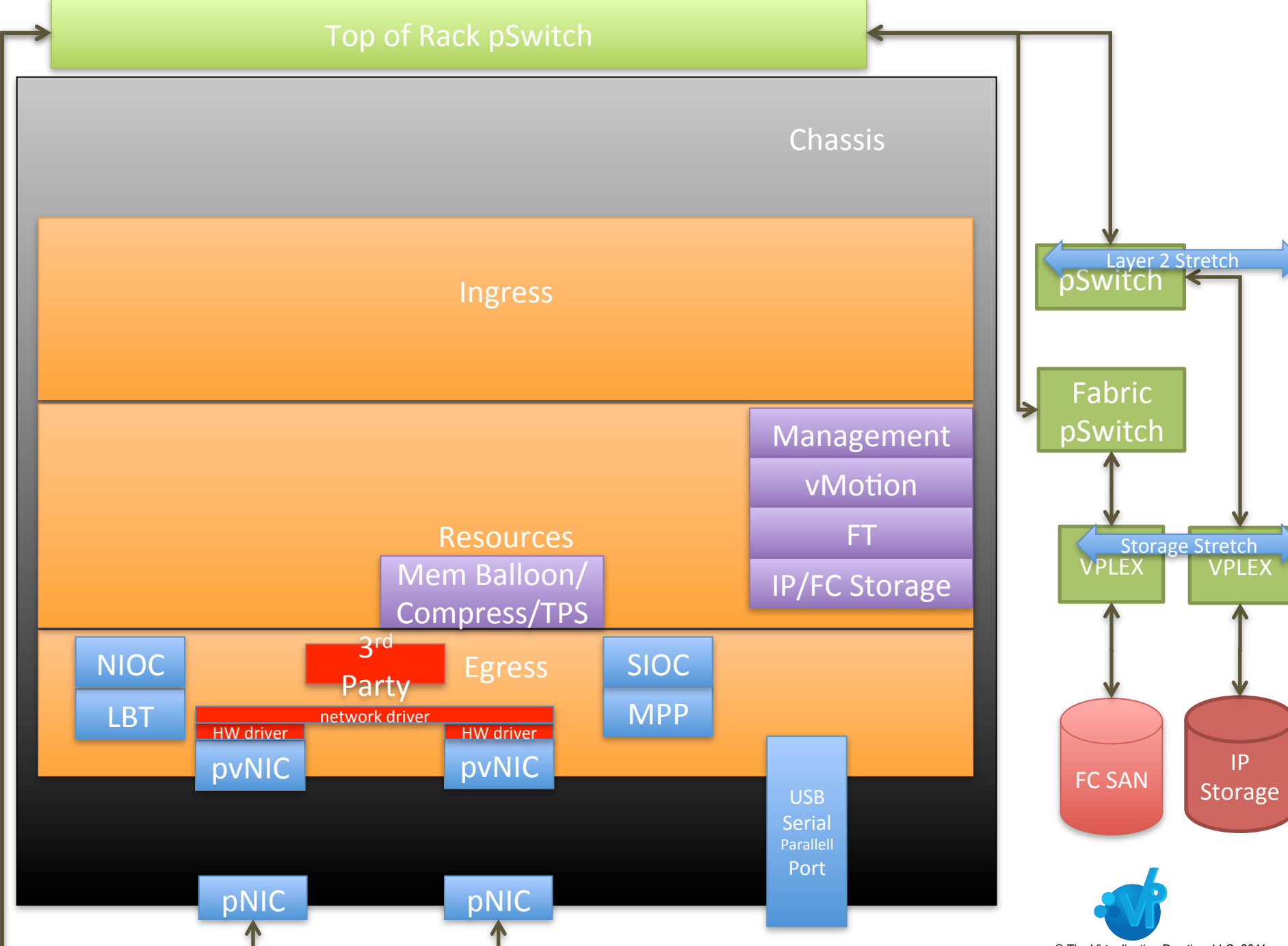

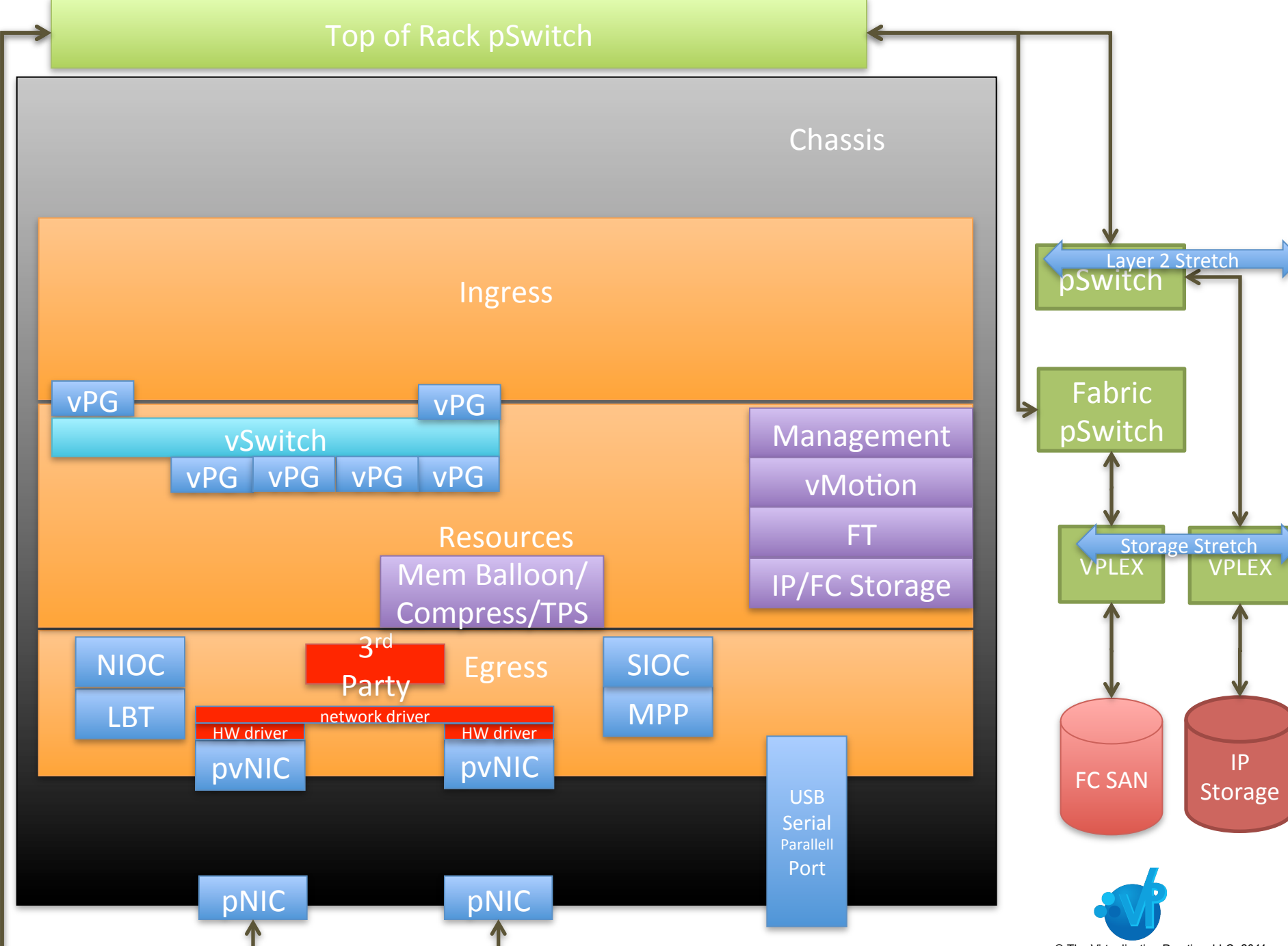

Top of Rack pSwitch

Chassis

Ingress

VMsafe-Net

VMsafe-Mem

VFILE

Management

vMotion

FT

IP/FC Storage

Resources

Mem Balloon/
Compress/TPS

3rd Party
network driver

Egress

SIOC

MPP

NIOC

LBT

pNIC

pNIC

USB
Serial
Parallel
Port

vPG

vPG

vSwitch

vPG

vPG

vPG

vPG

HW driver
pvNIC

HW driver
pvNIC

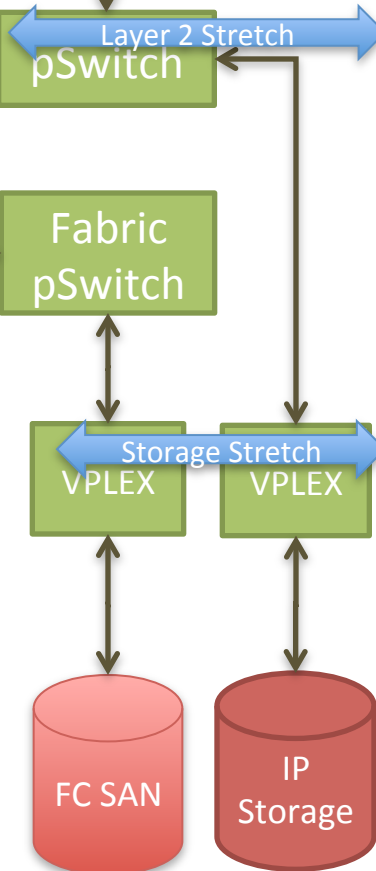

Top of Rack pSwitch

Chassis

Ingress

- N-Pipe
- VMCI
- VIX
- VMsafe

- VMsafe-Net
- VMsafe-Mem
- VFILE

vPG

vPG

vSwitch

- vPG
- vPG
- vPG
- vPG

Resources

Mem Balloon/
Compress/TPS

- Management
- vMotion
- FT
- IP/FC Storage

NIOC

LBT

3rd Party
network driver

Egress

SIOC

MPP

HW driver
pvNIC

HW driver
pvNIC

pNIC

pNIC

USB
Serial
Parallel
Port

Layer 2 Stretch
pSwitch

Fabric
pSwitch

Storage Stretch
VPLEX

VPLEX

FC SAN

IP
Storage



Top of Rack pSwitch

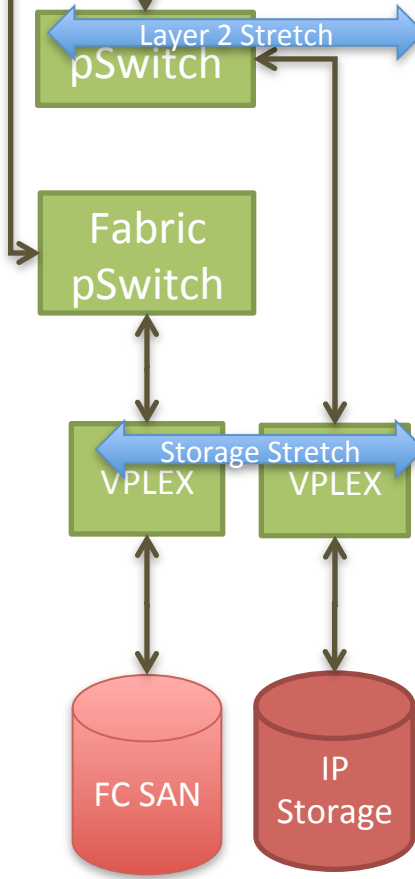
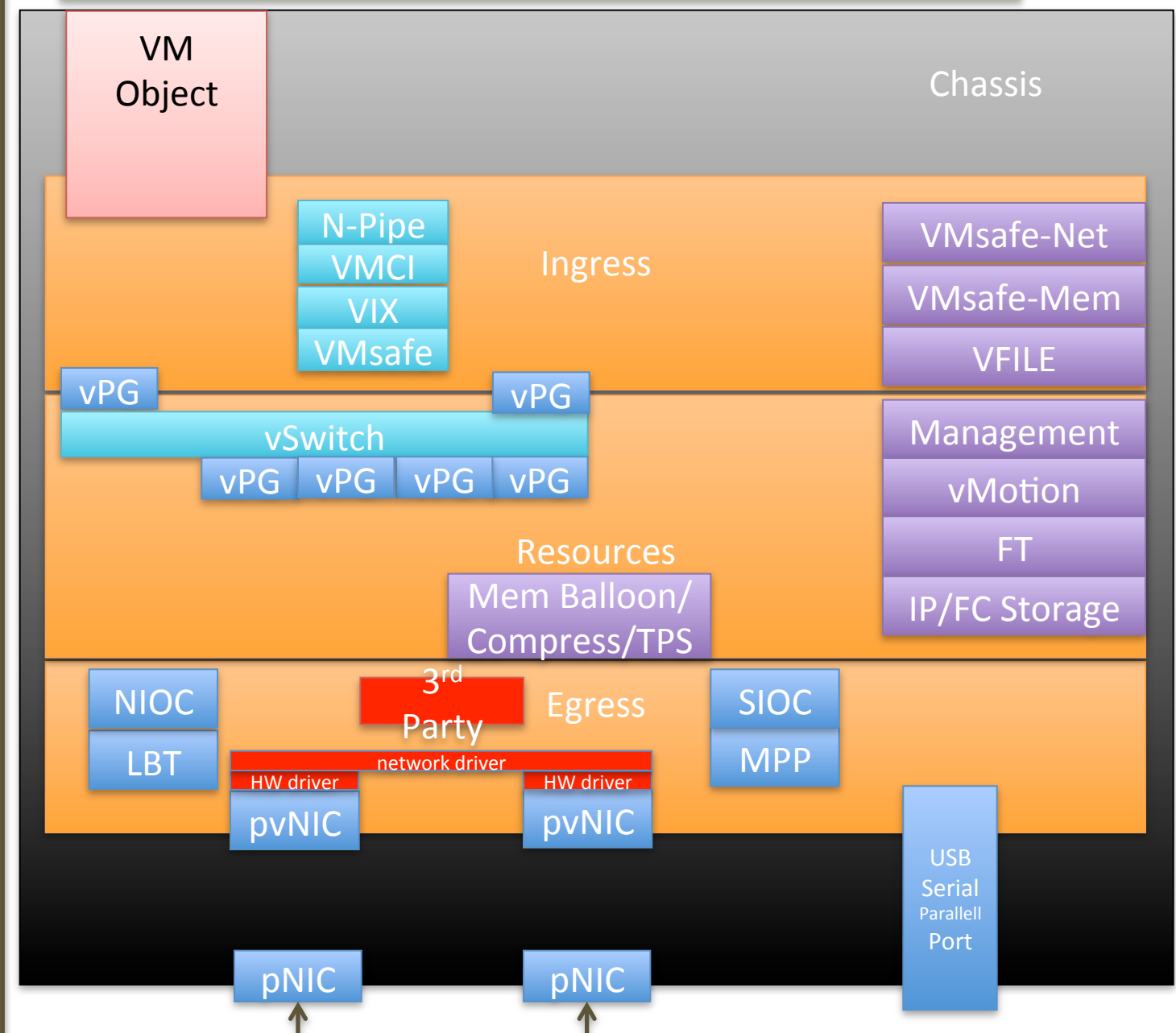

Top of Rack pSwitch

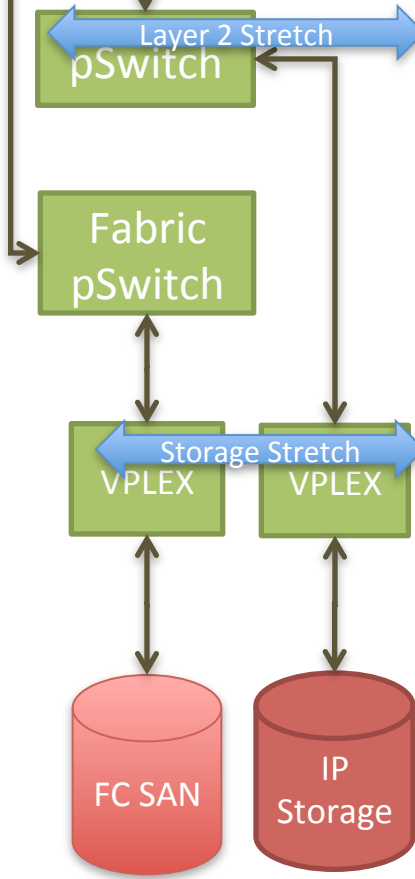
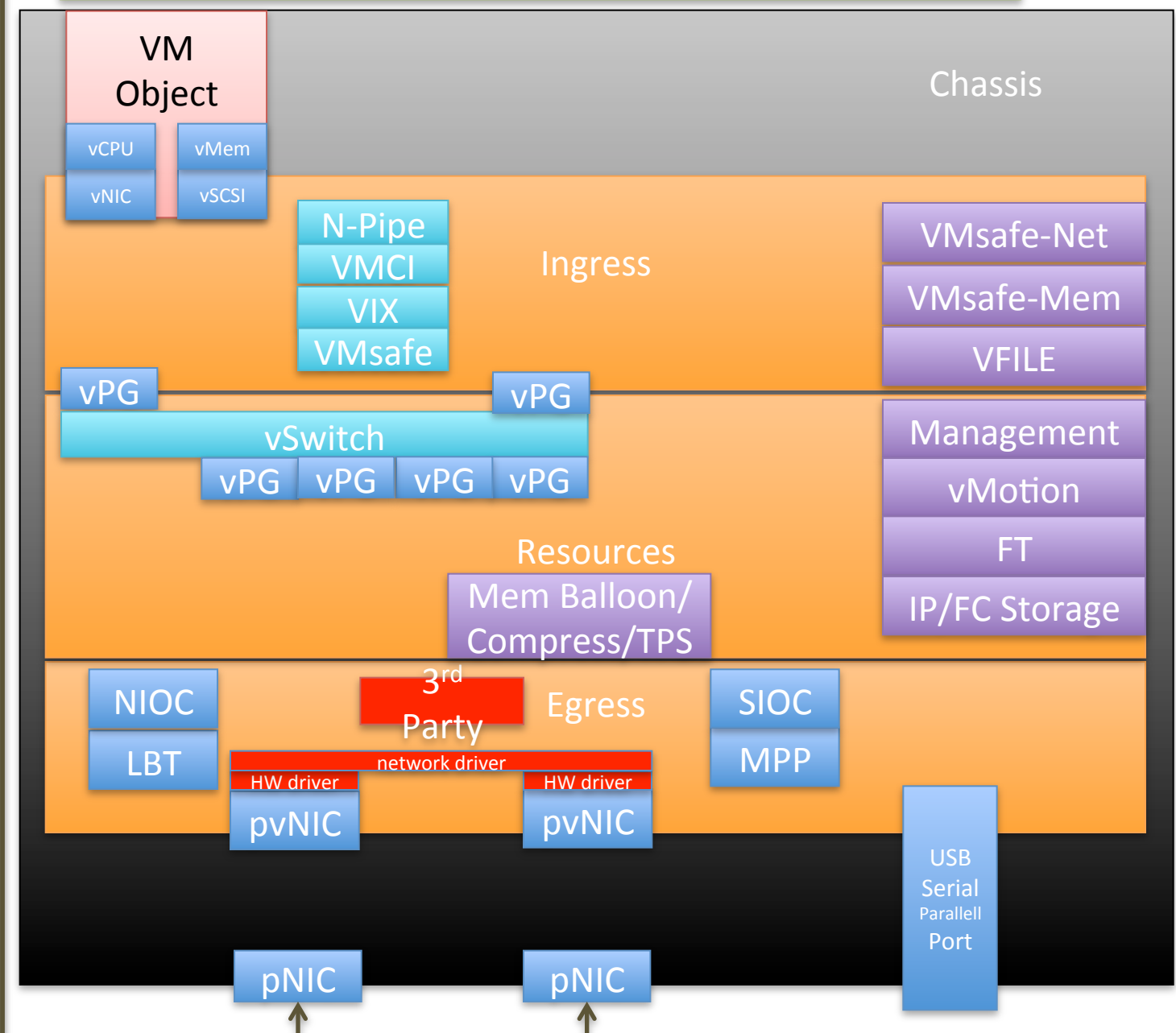

Top of Rack pSwitch

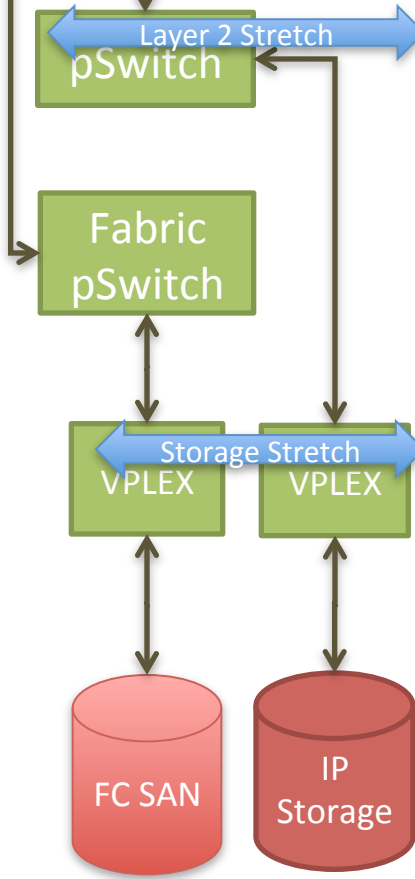
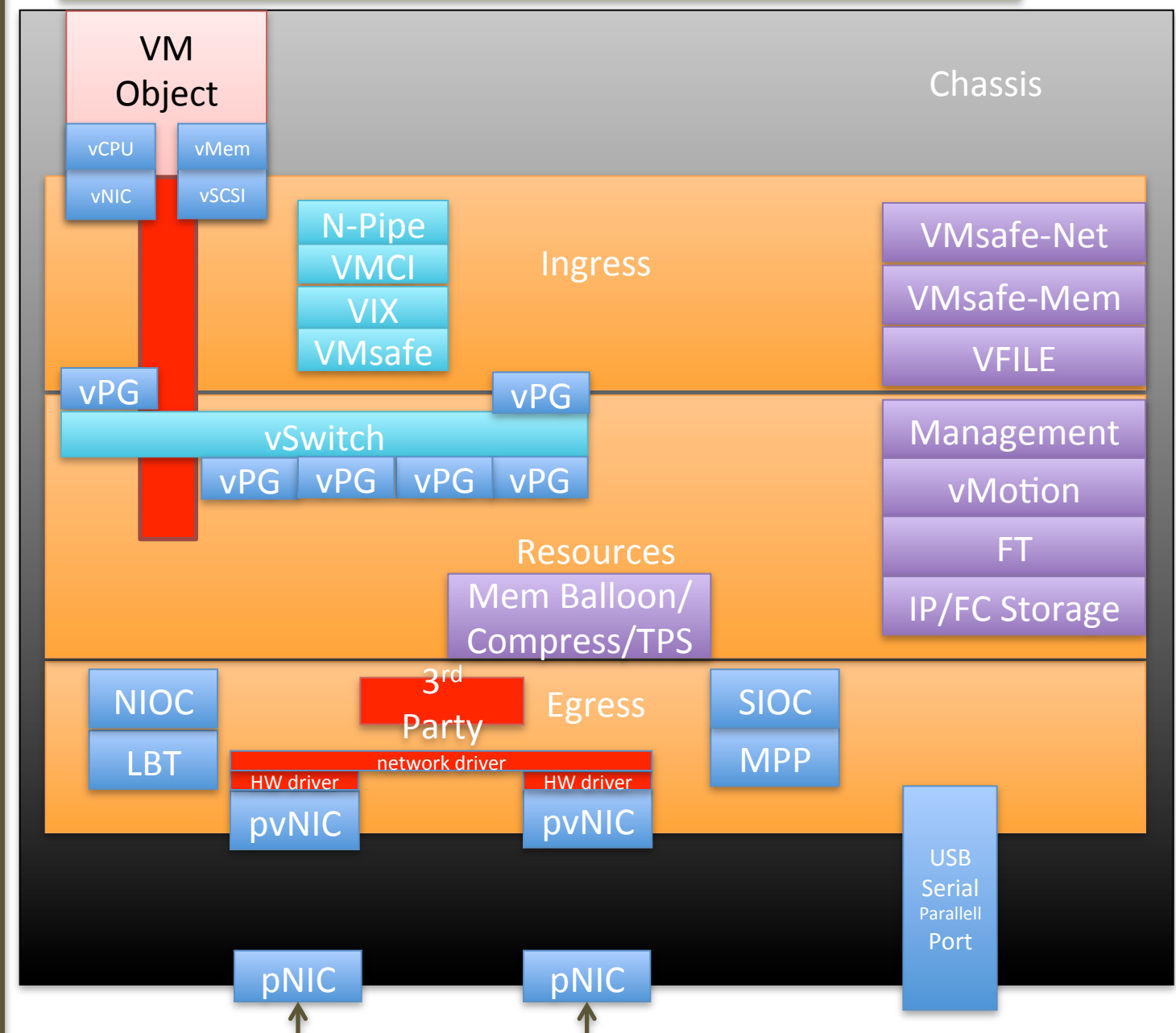

Top of Rack pSwitch

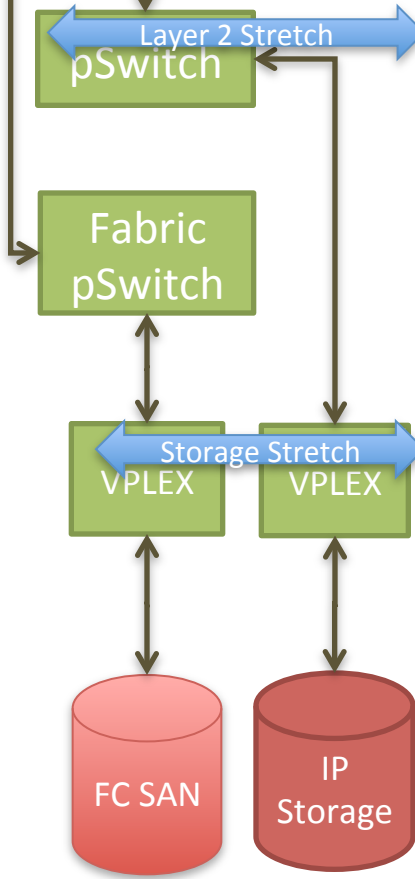
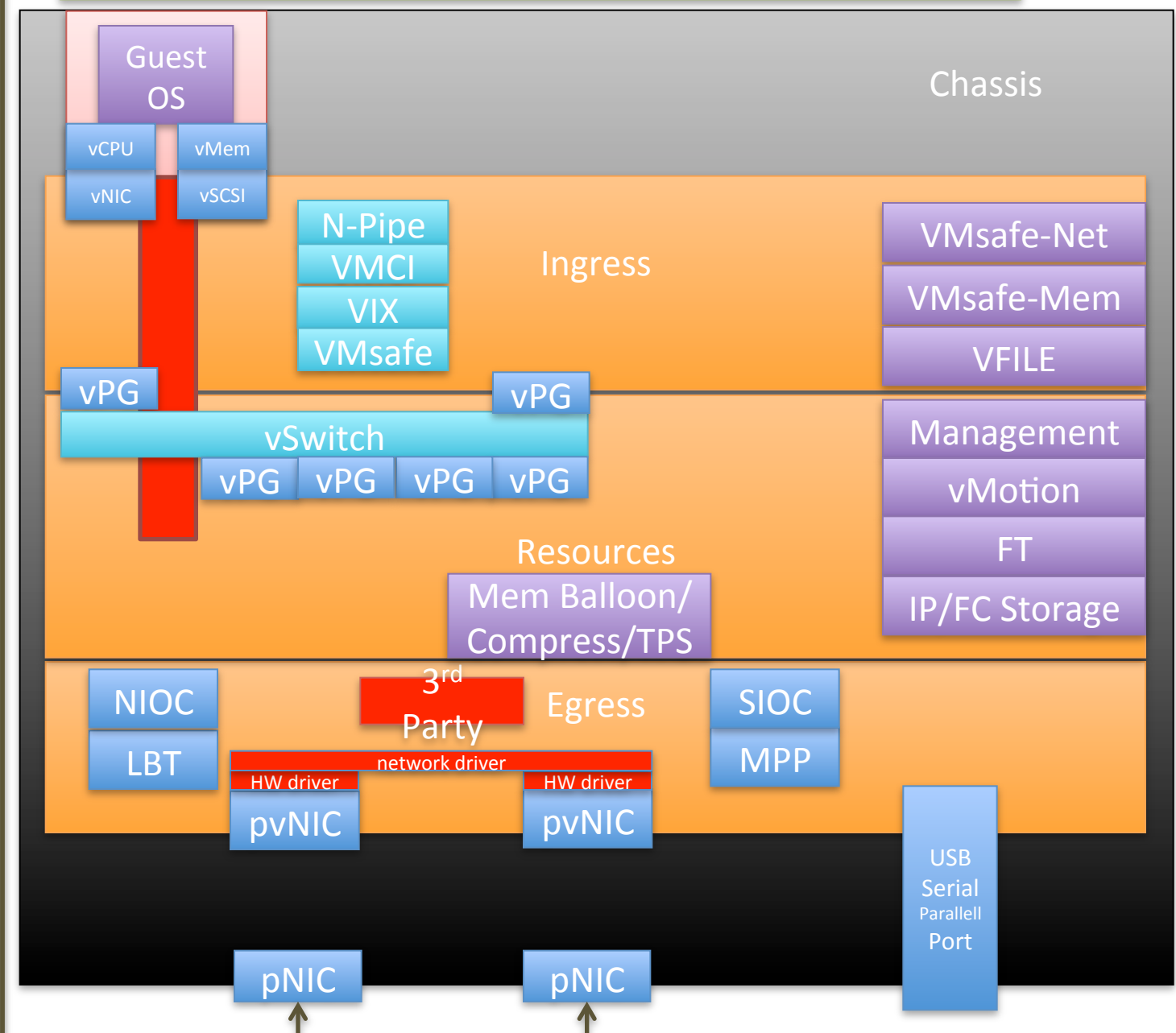

Top of Rack pSwitch

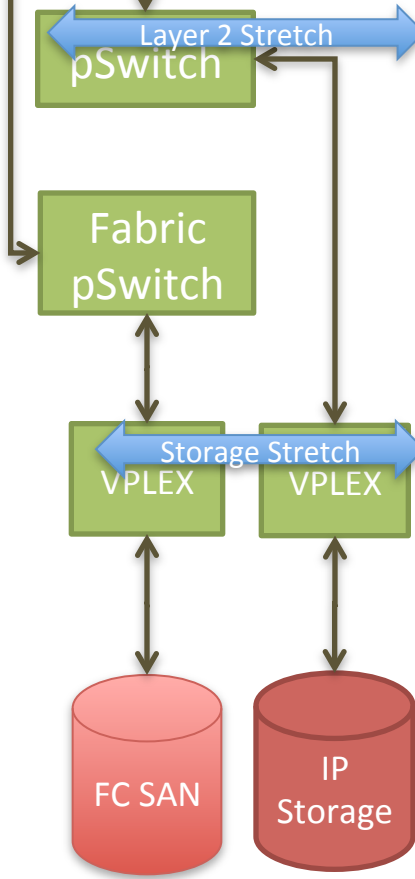
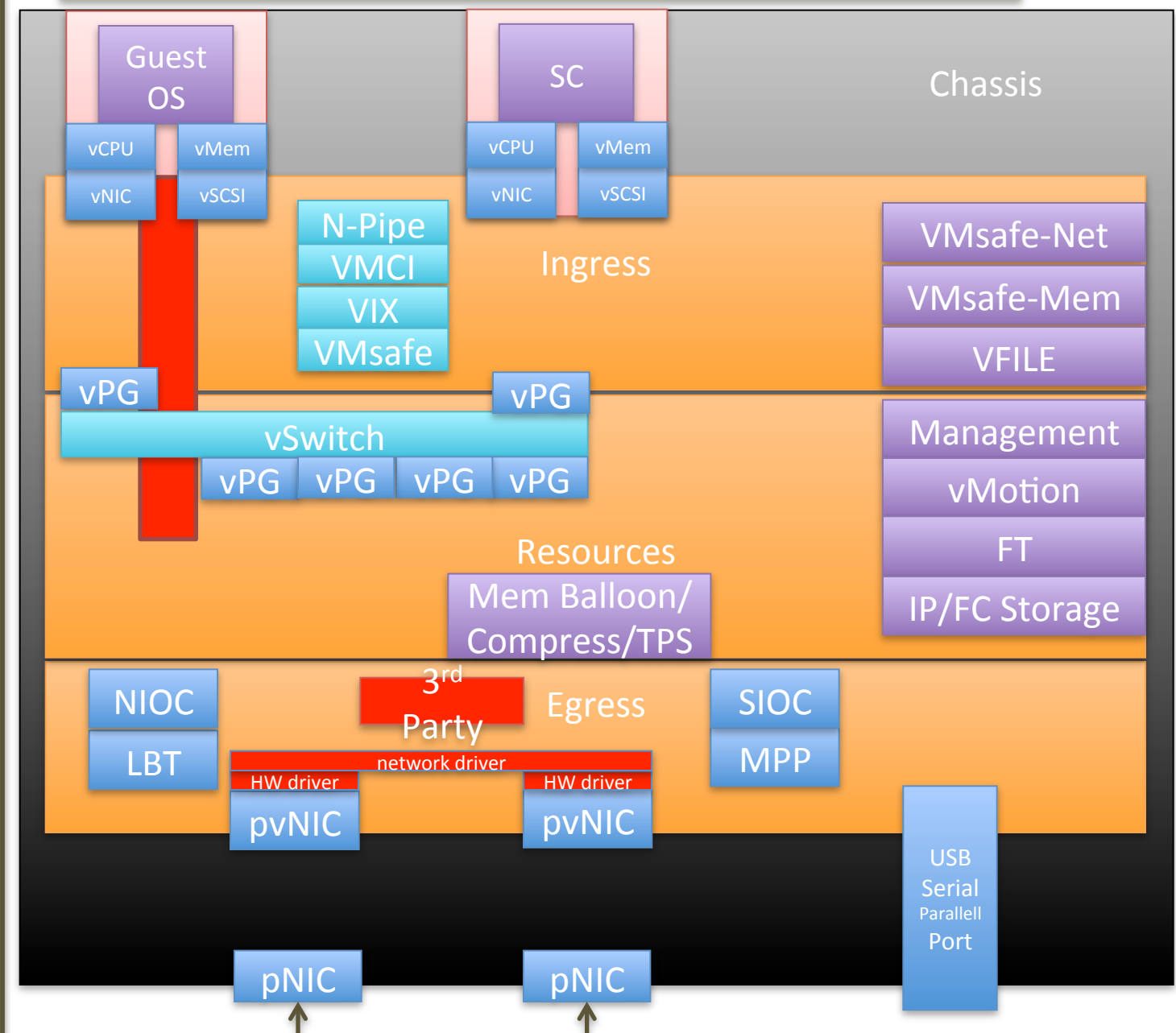

Top of Rack pSwitch

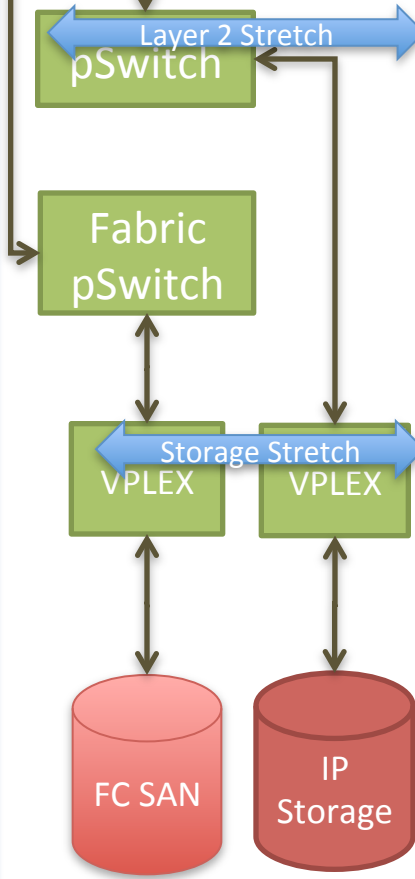
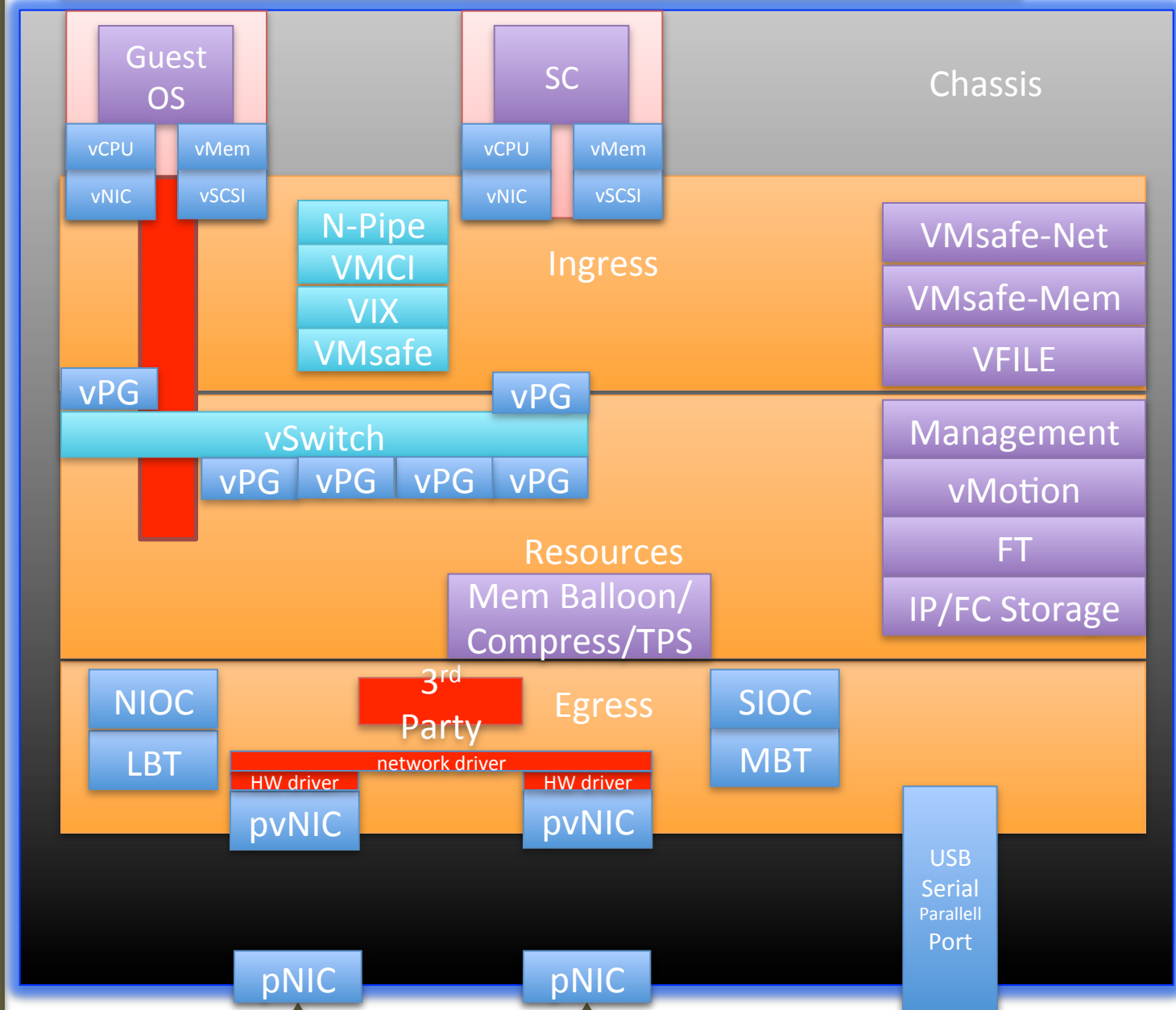

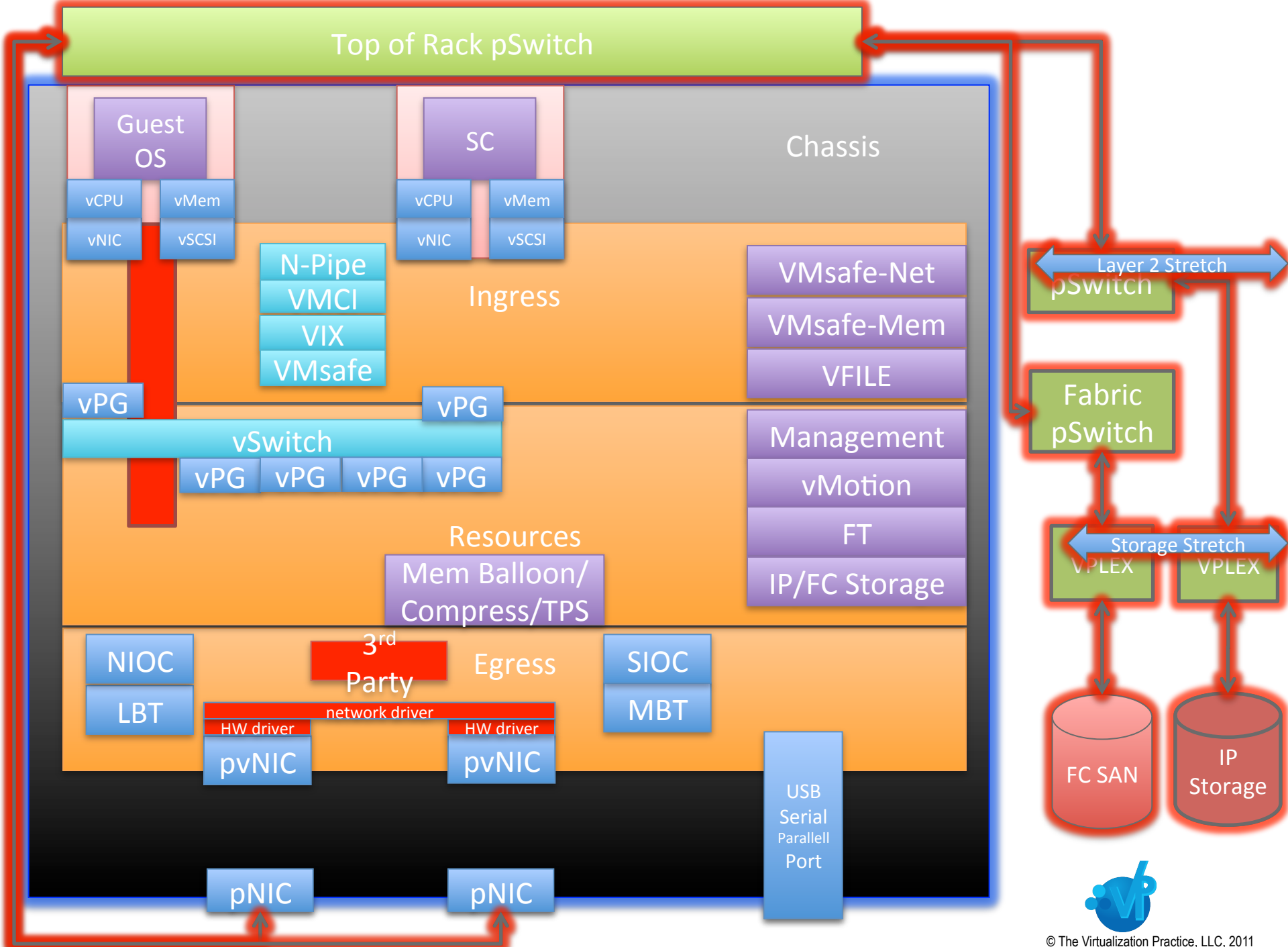

Top of Rack pSwitch

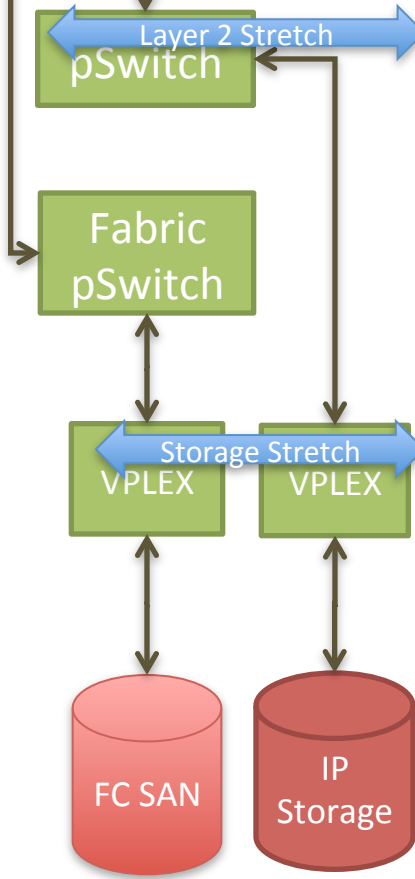
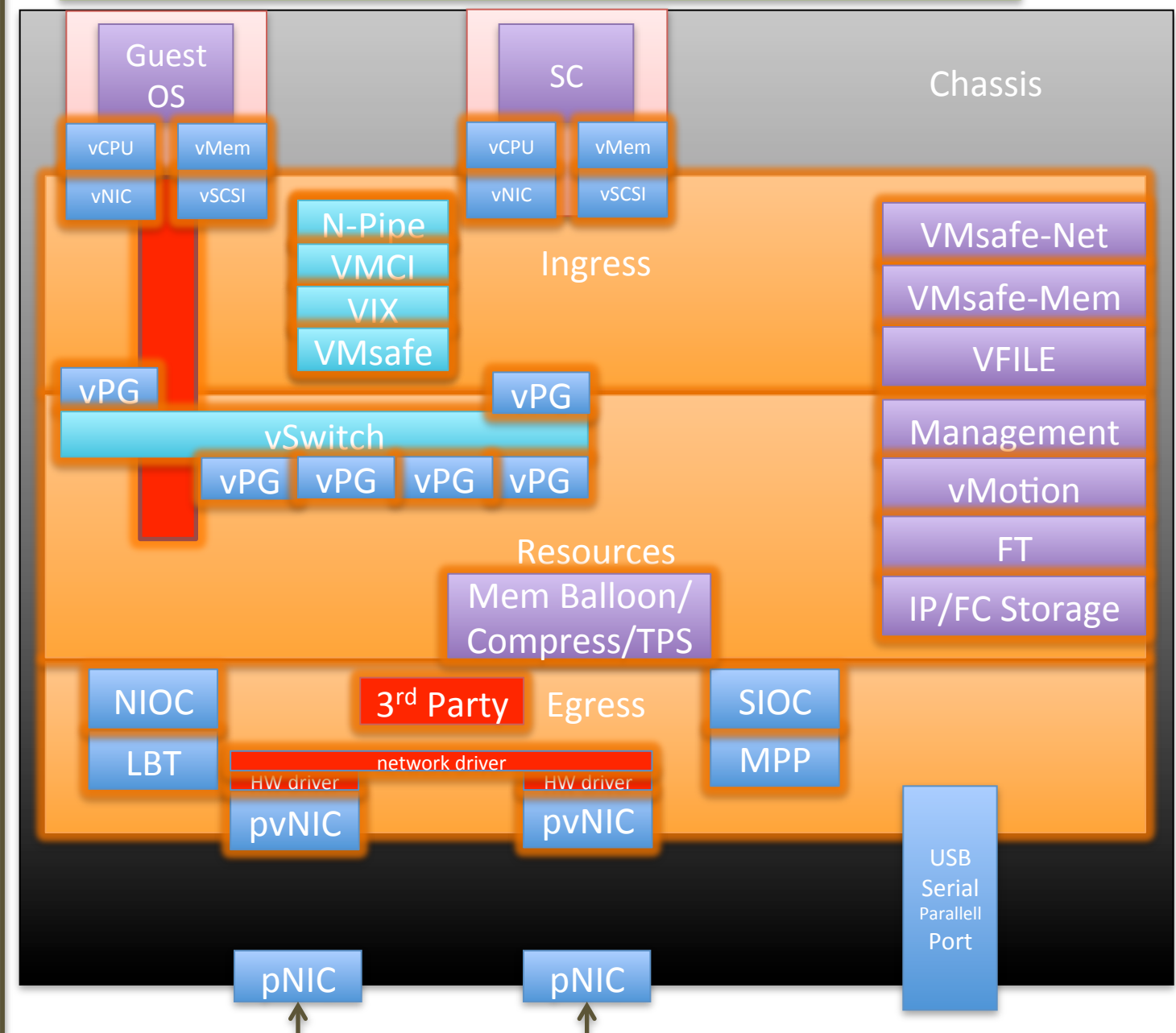

Top of Rack pSwitch

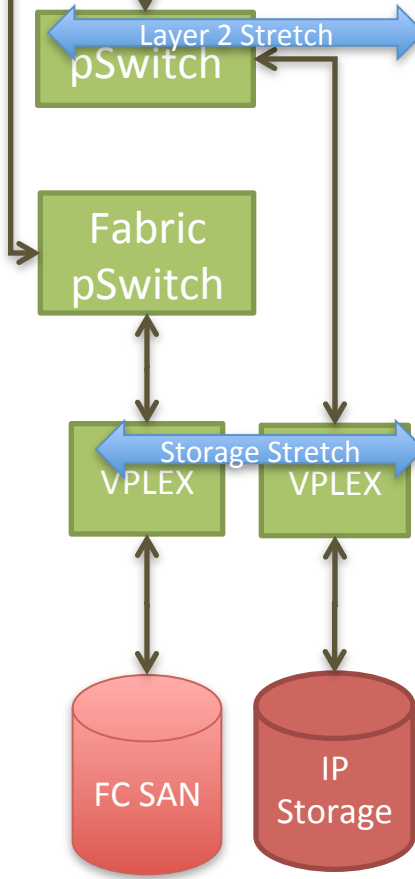
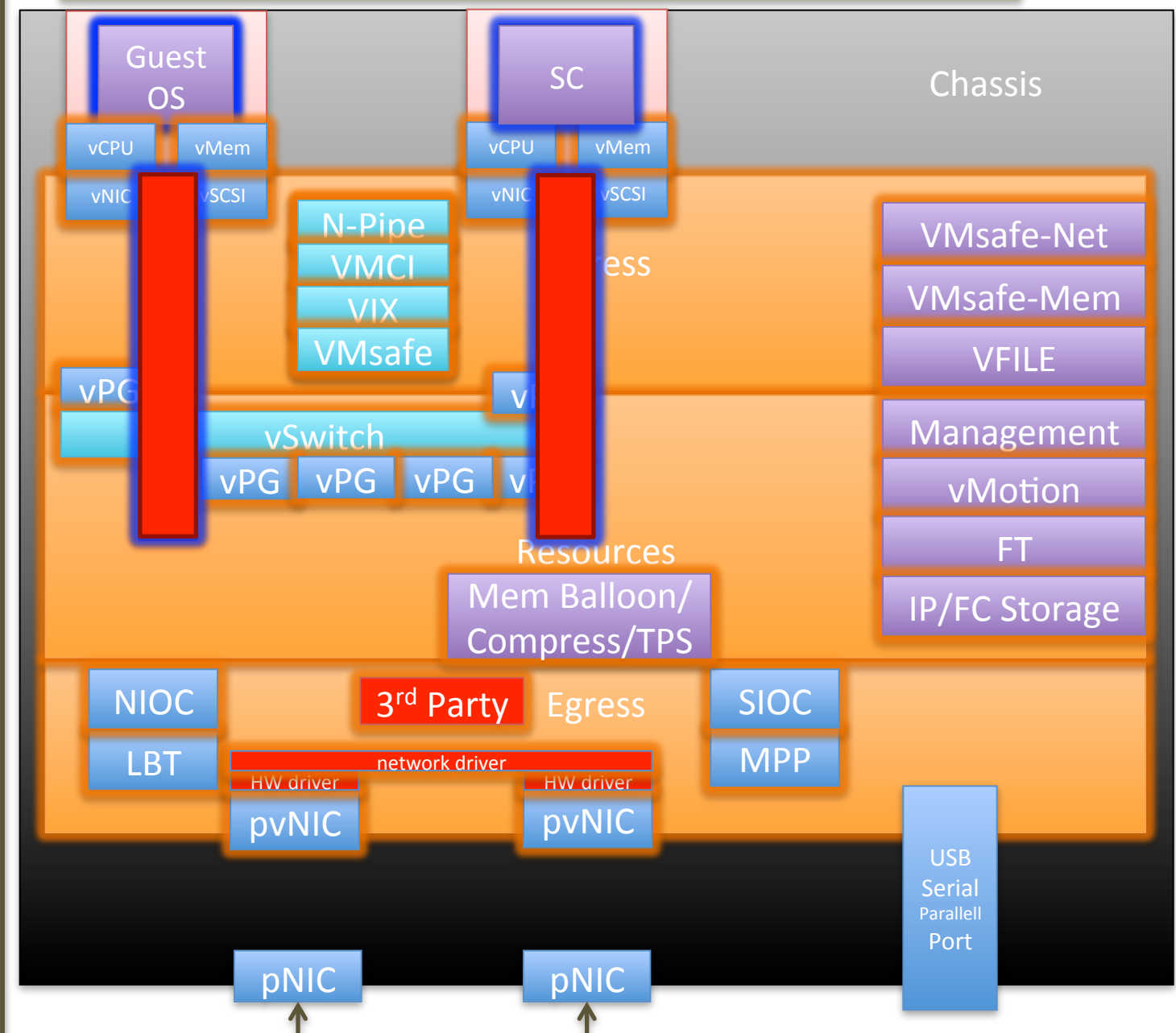

Top of Rack pSwitch

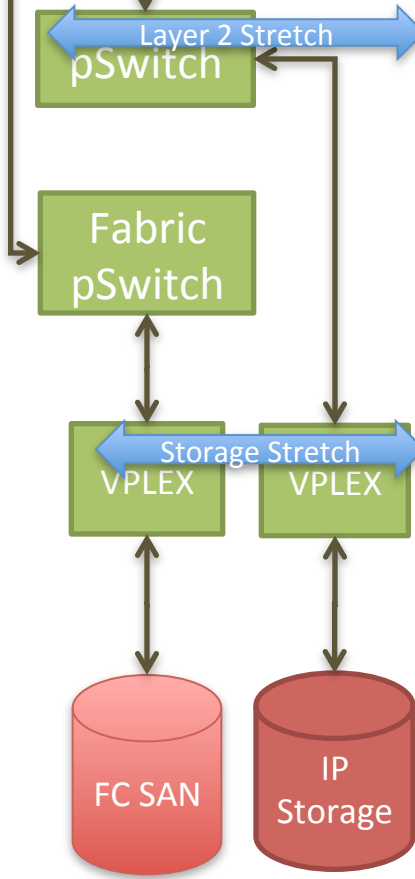
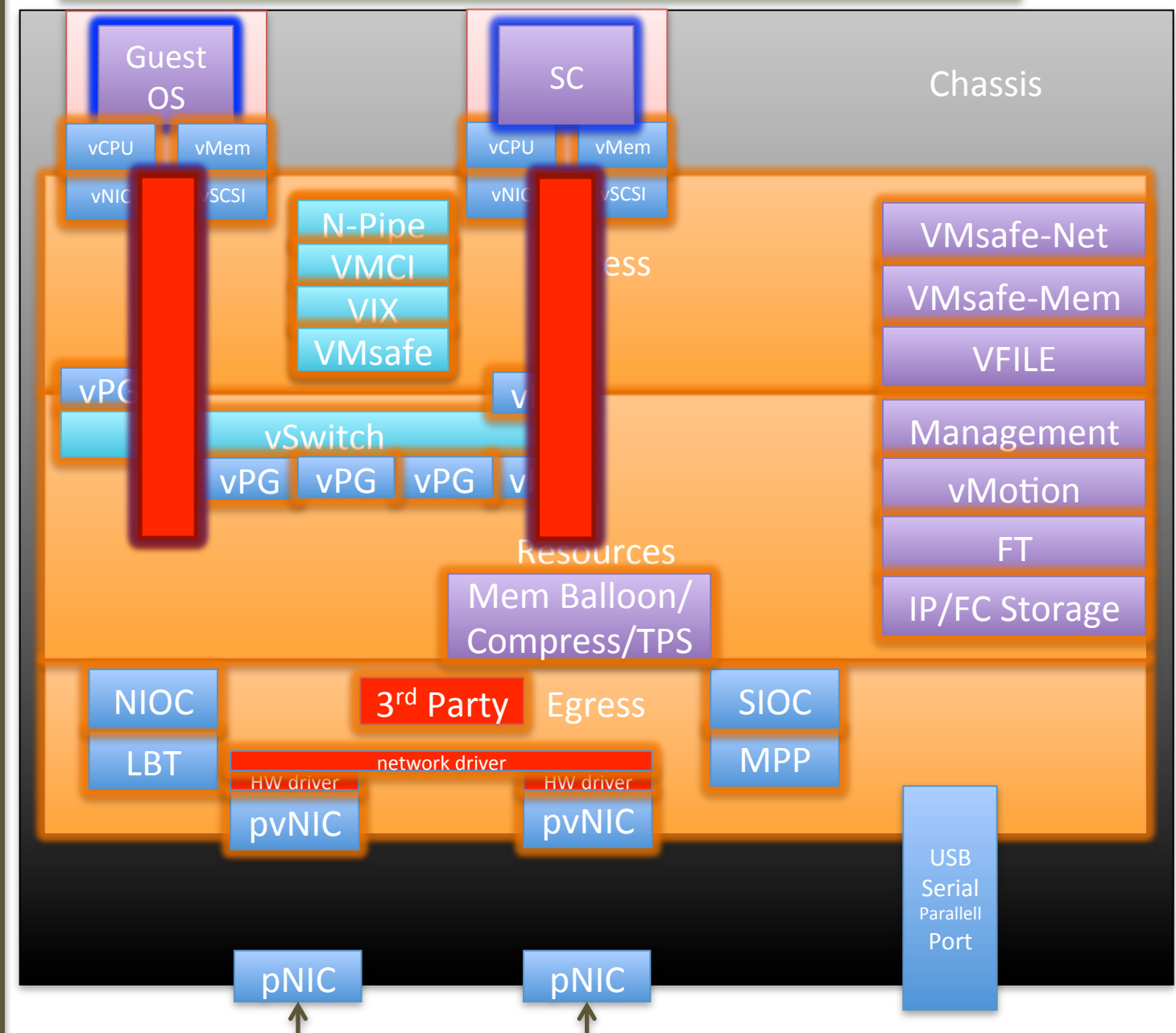

Top of Rack pSwitch

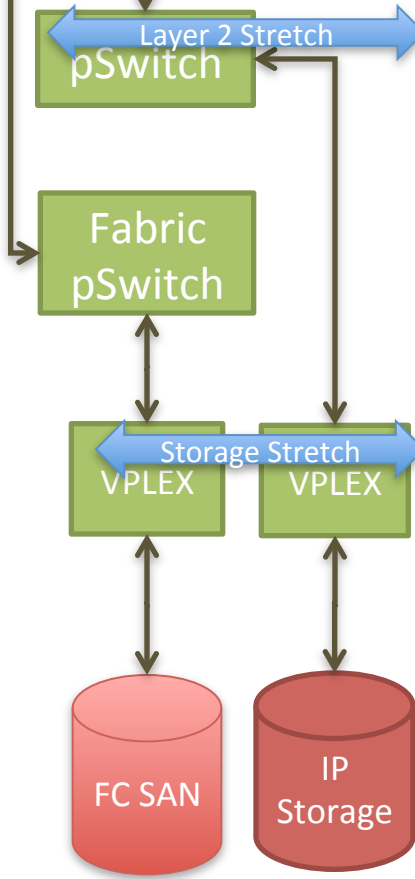
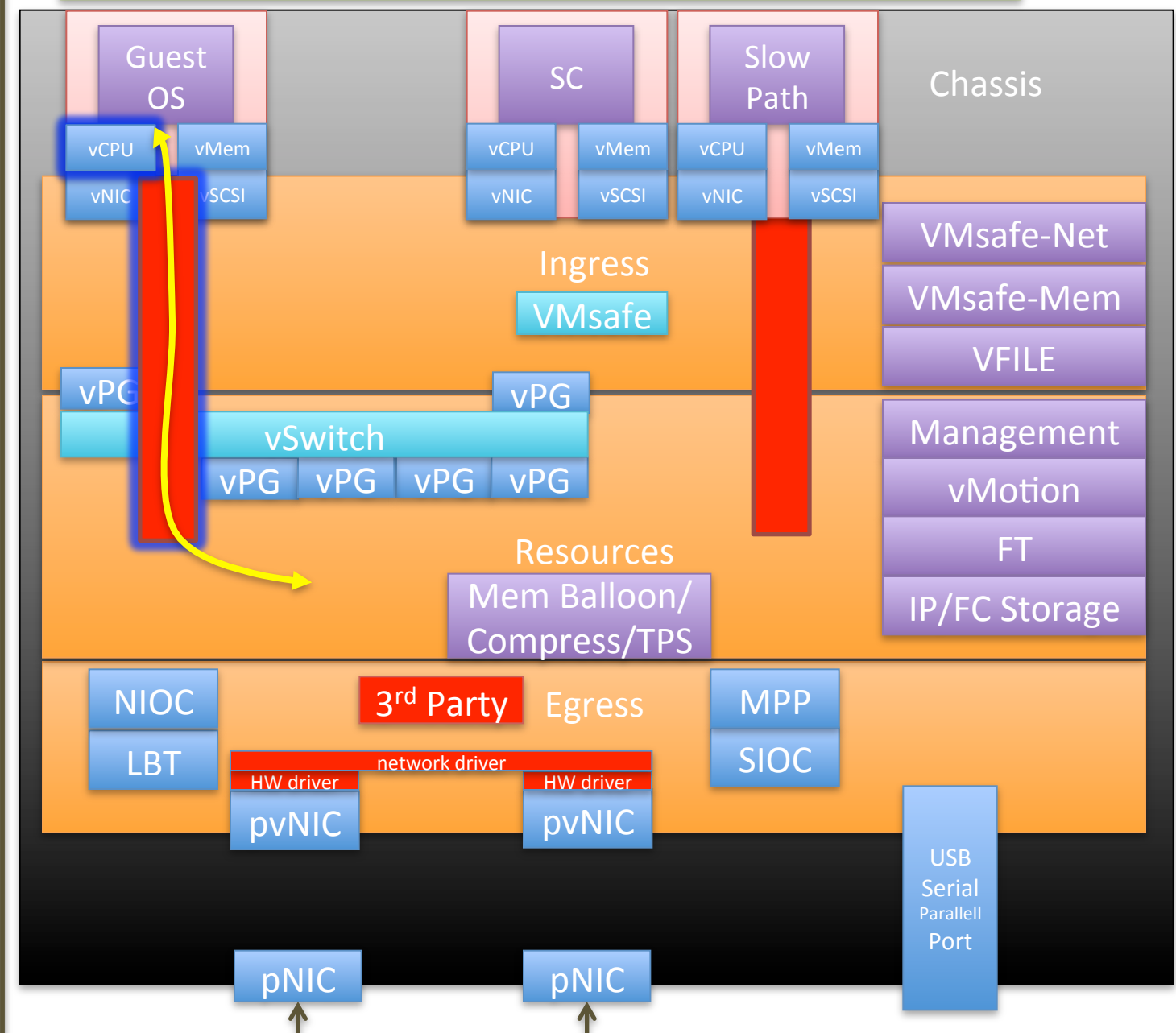

Top of Rack pSwitch

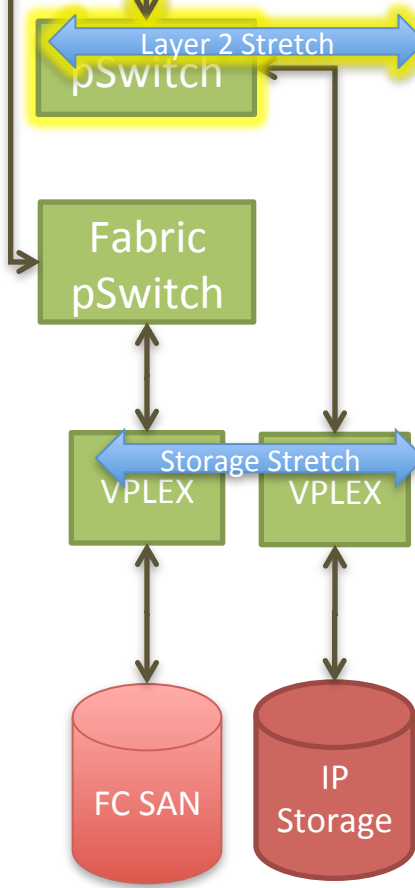
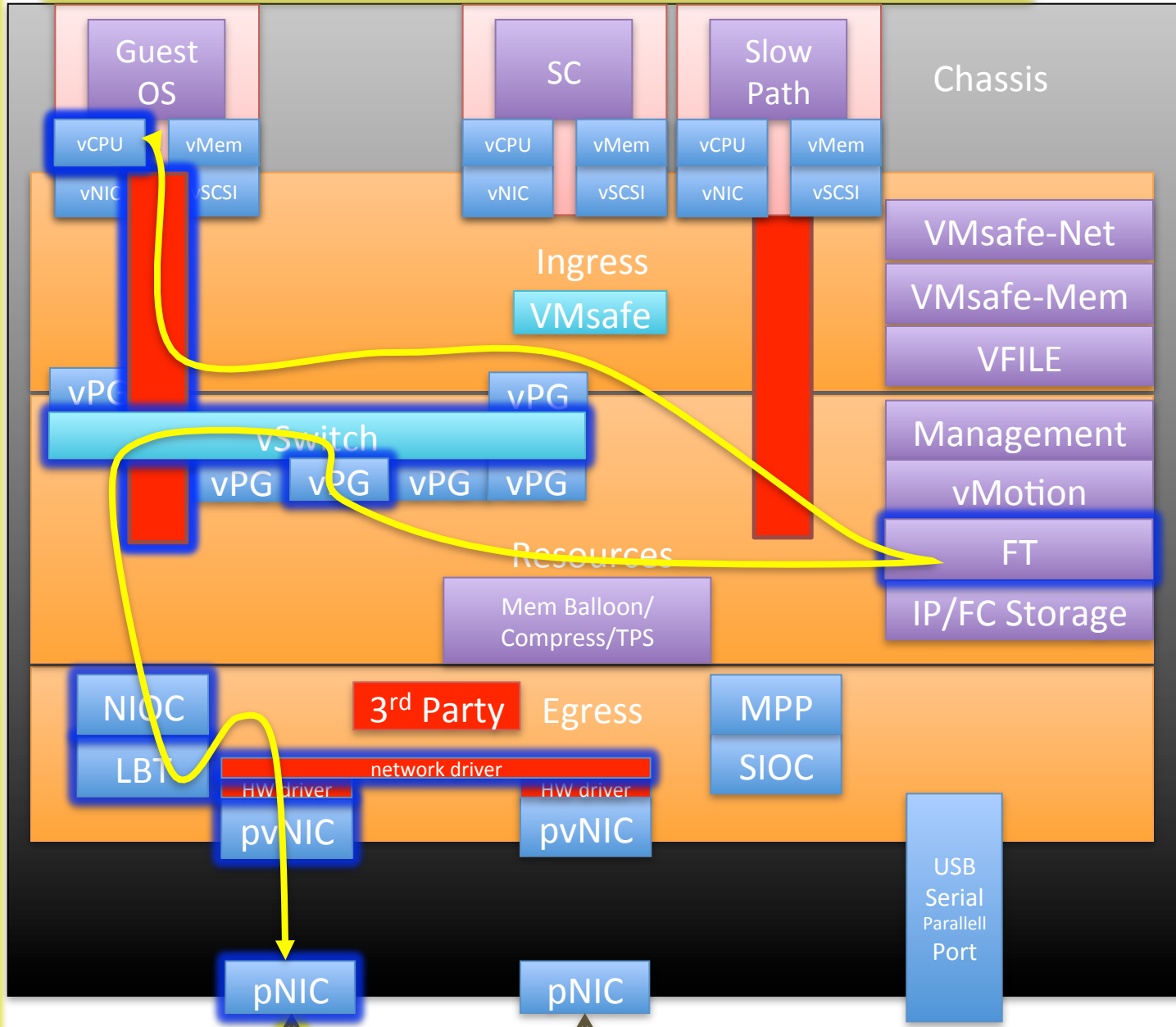

Top of Rack pSwitch

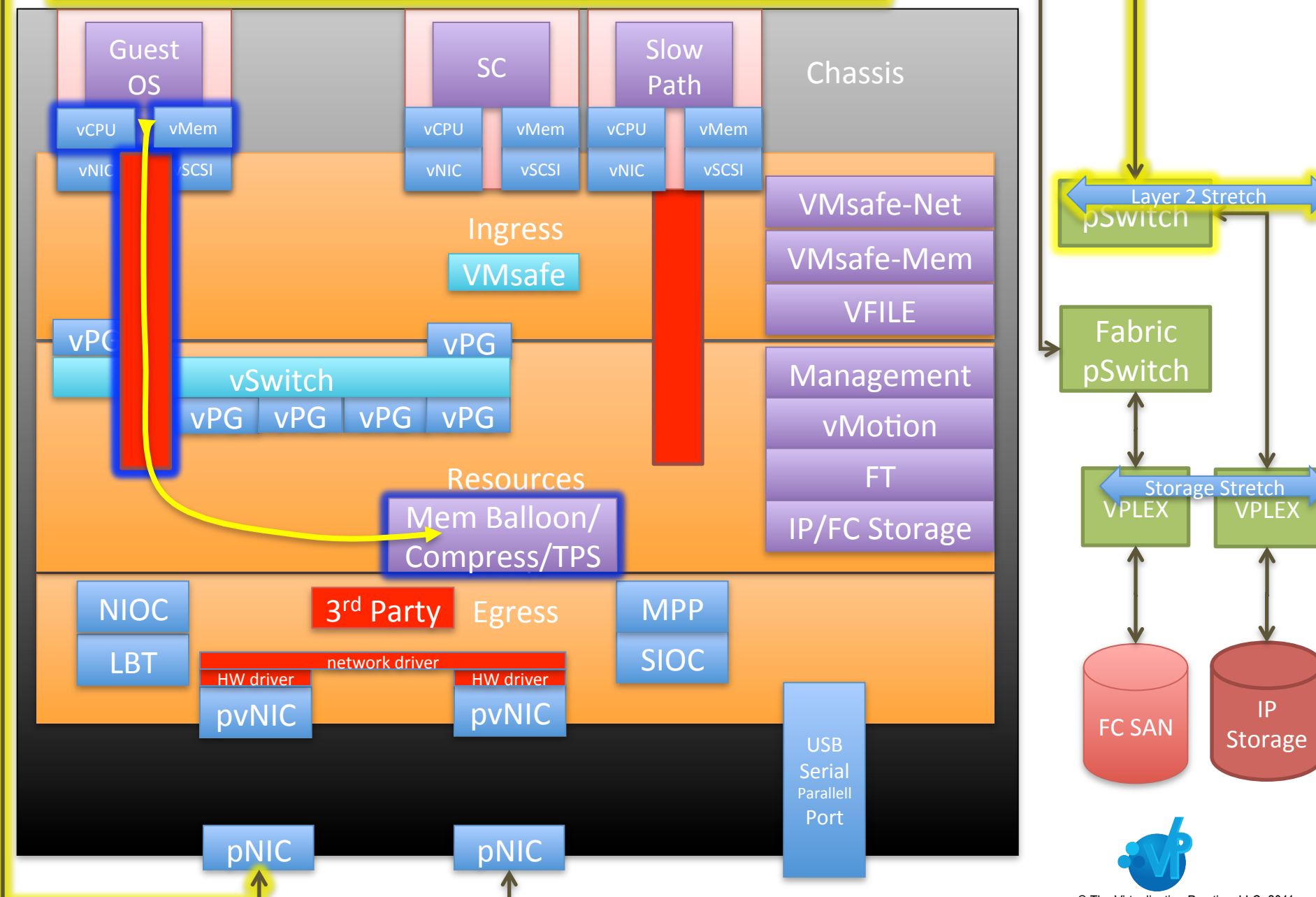

Top of Rack pSwitch

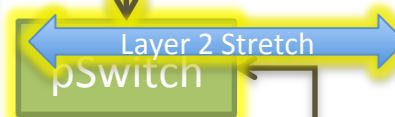
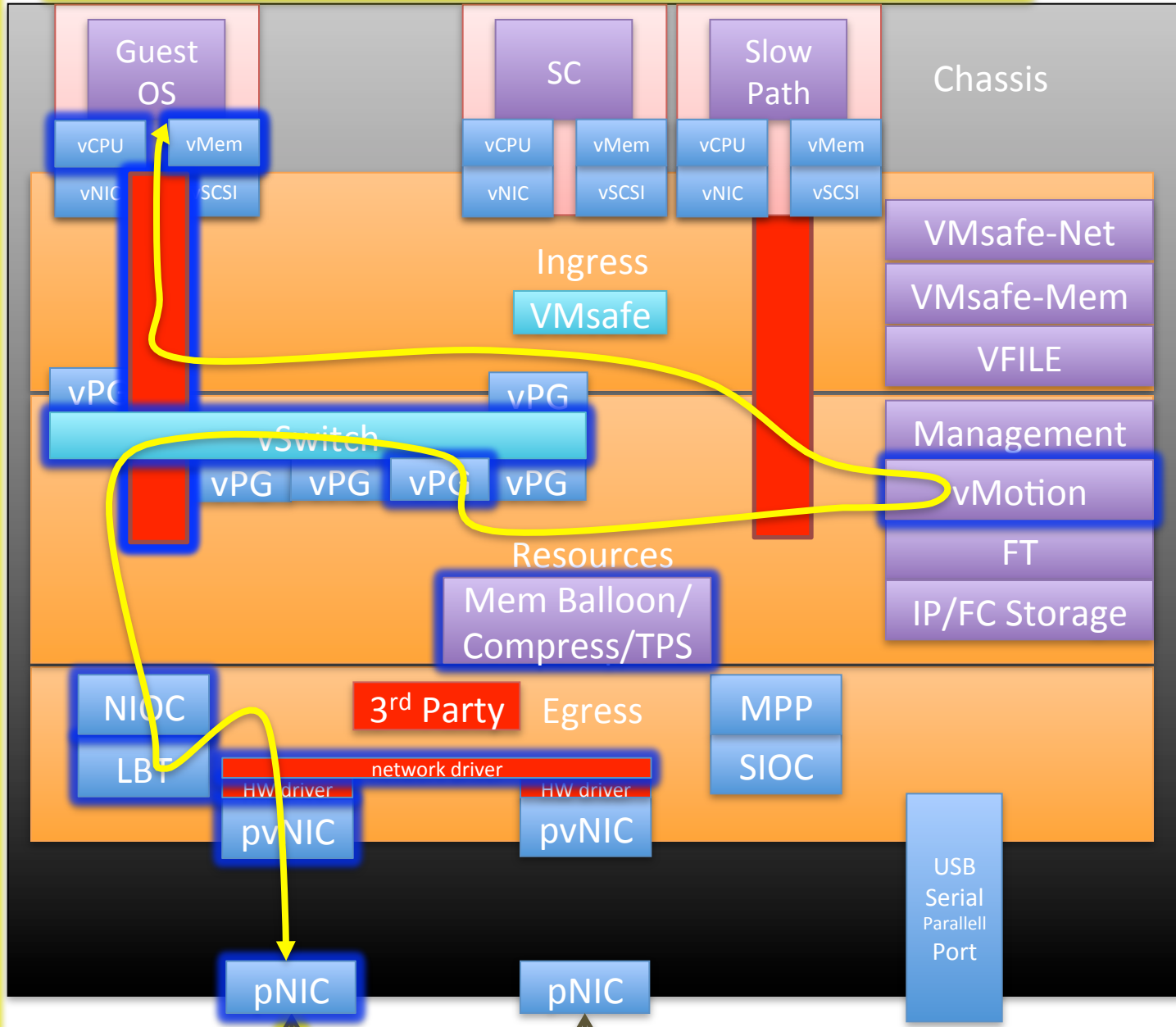

Top of Rack pSwitch

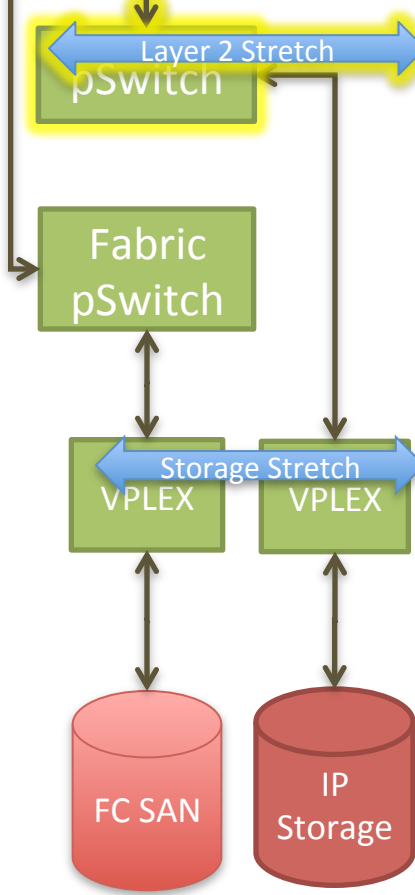
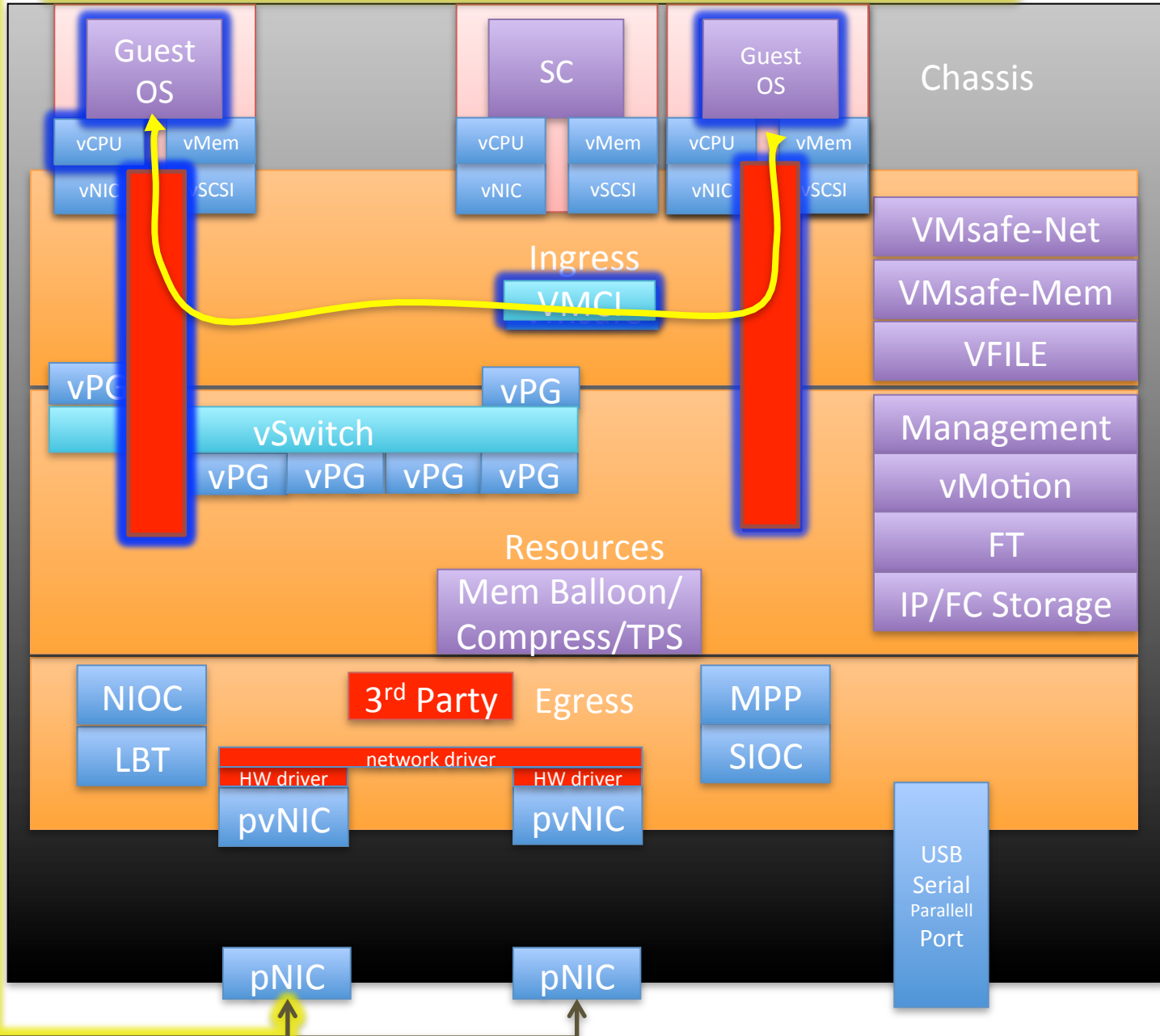

Top of Rack pSwitch

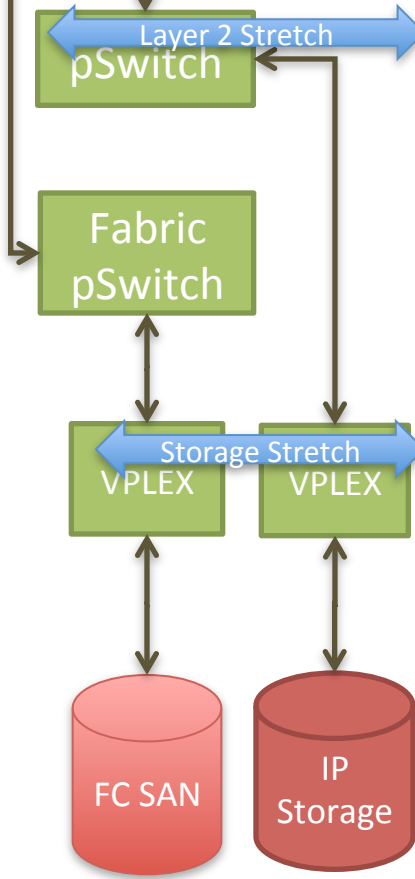
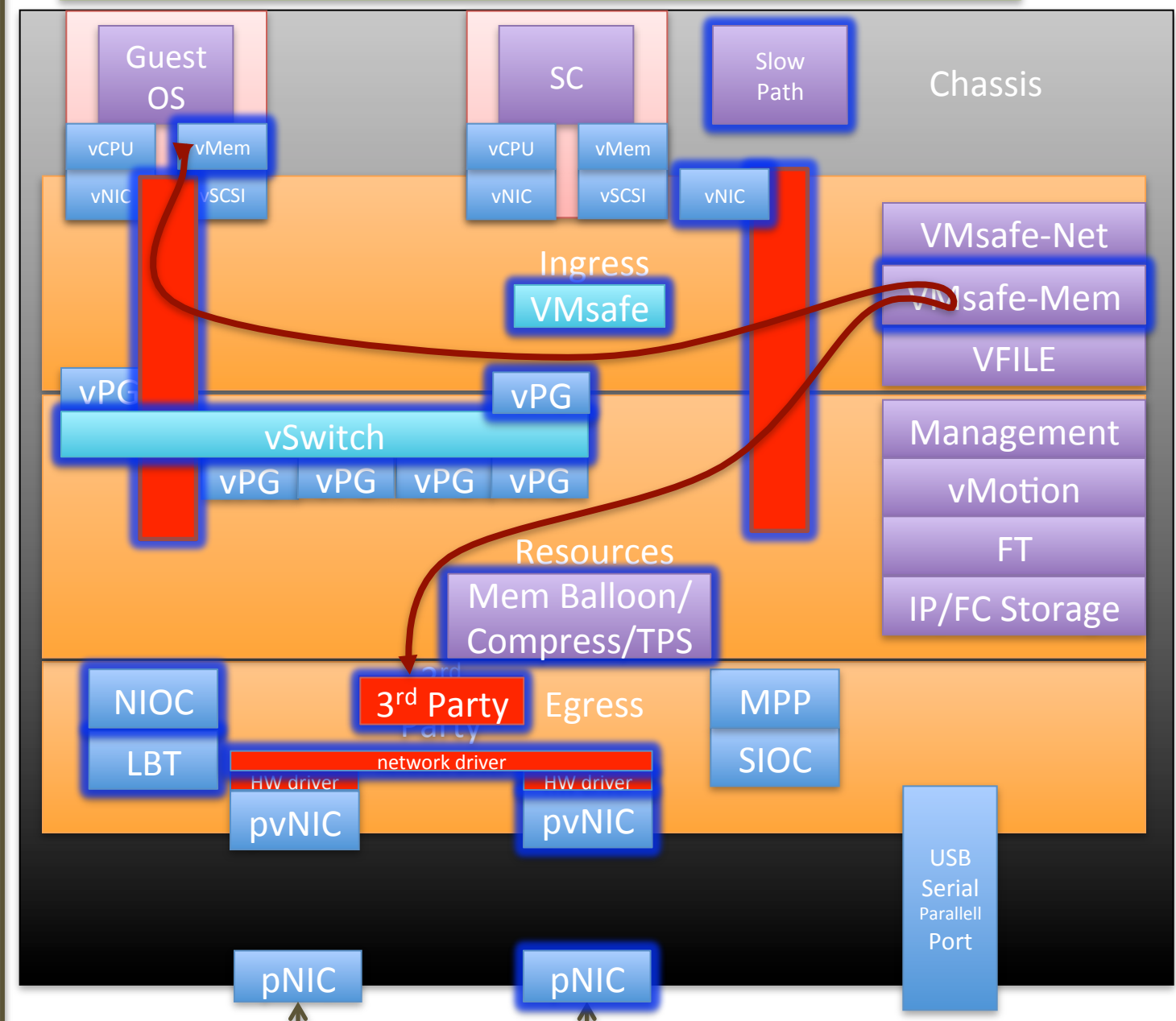

Top of Rack pSwitch

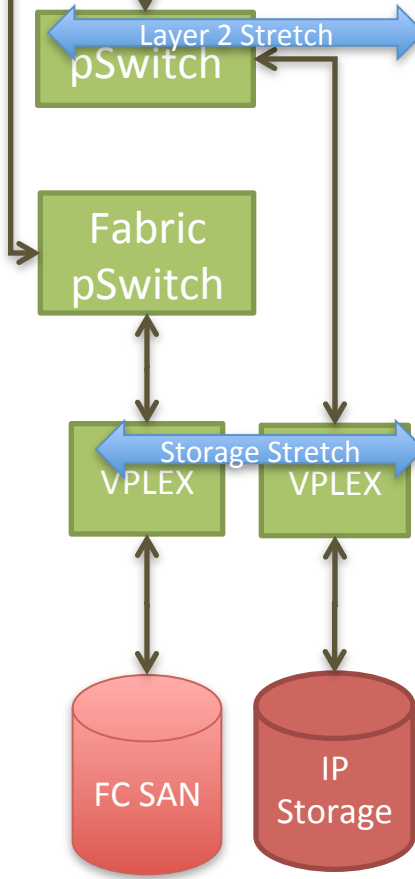
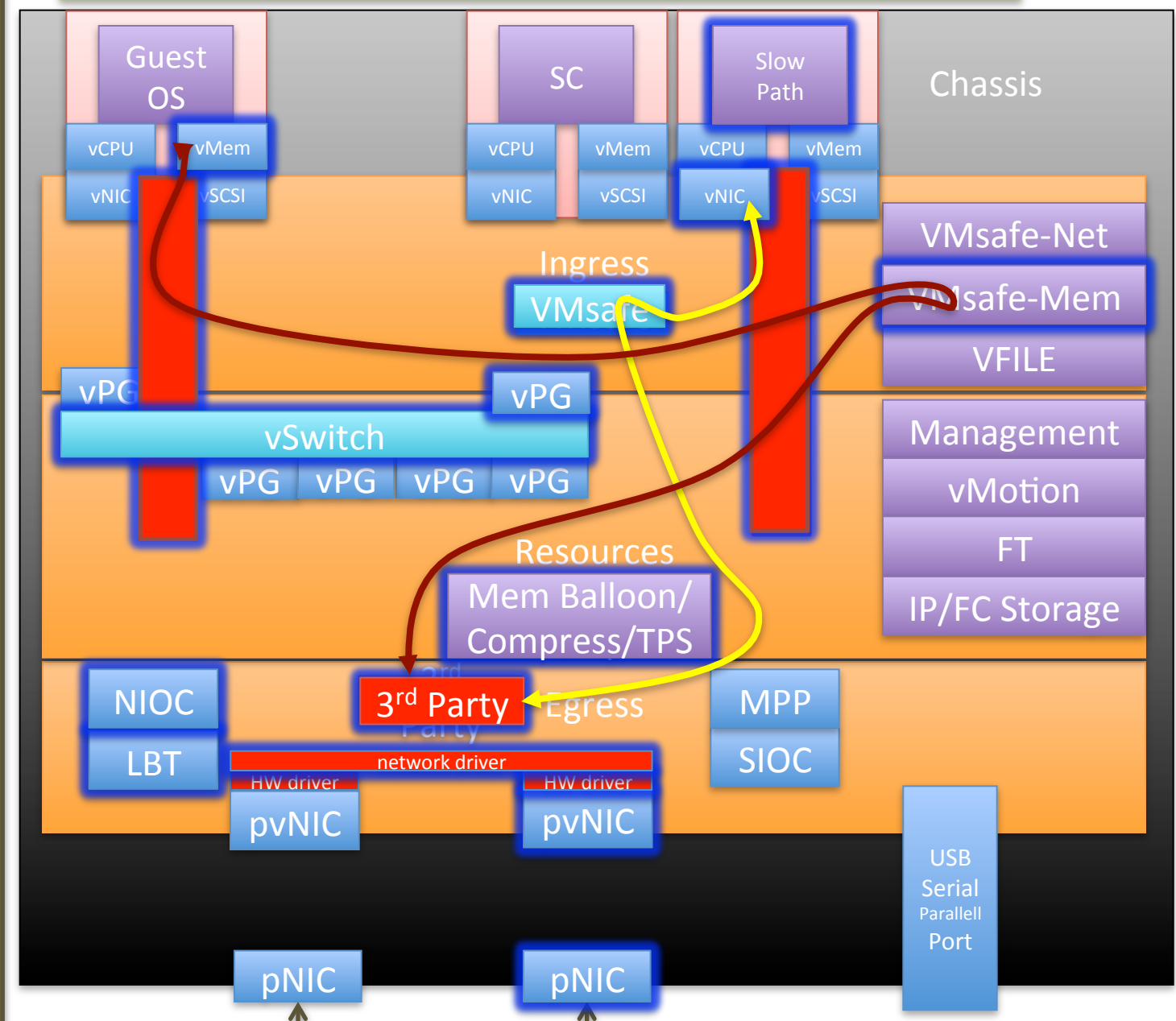

Top of Rack pSwitch

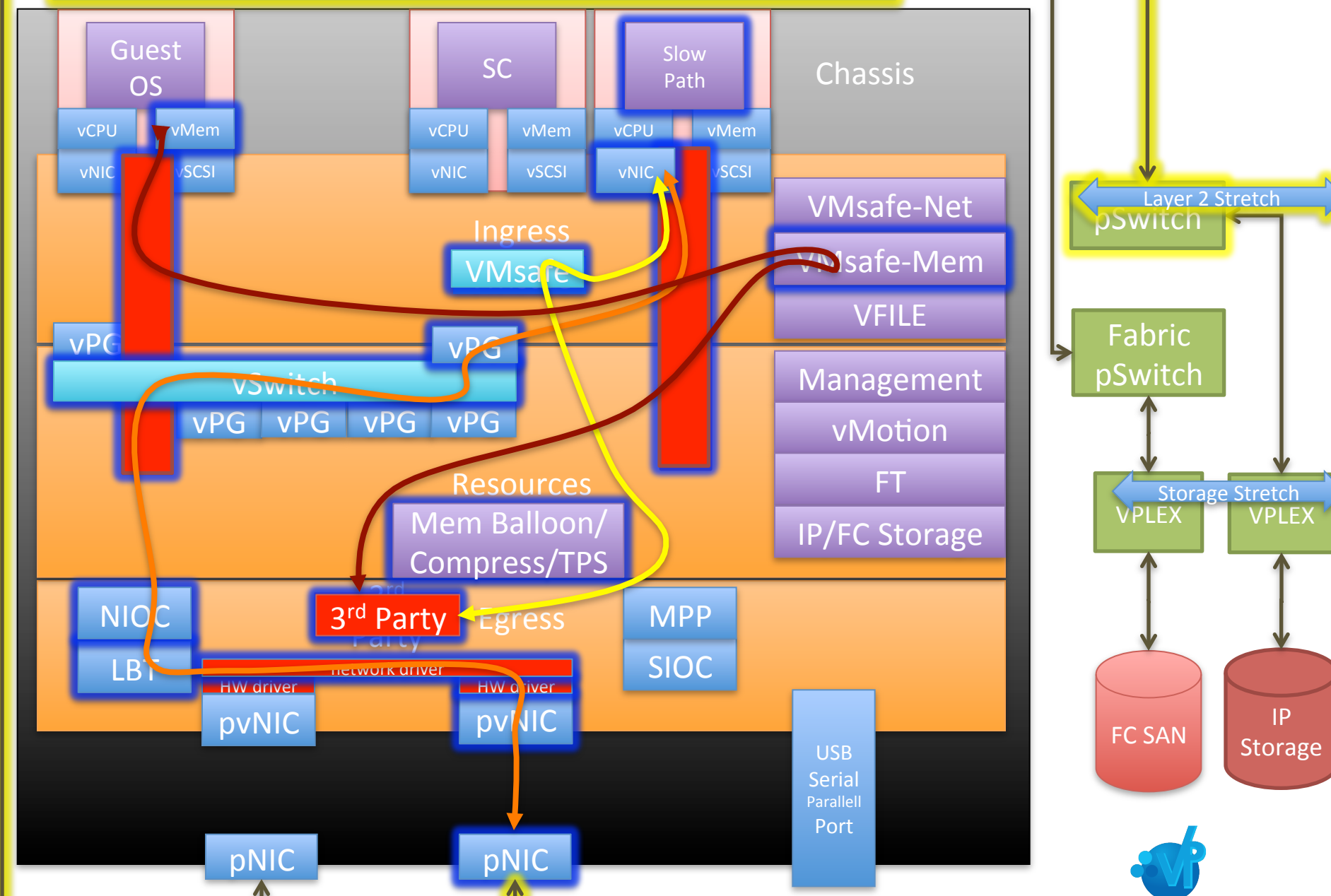

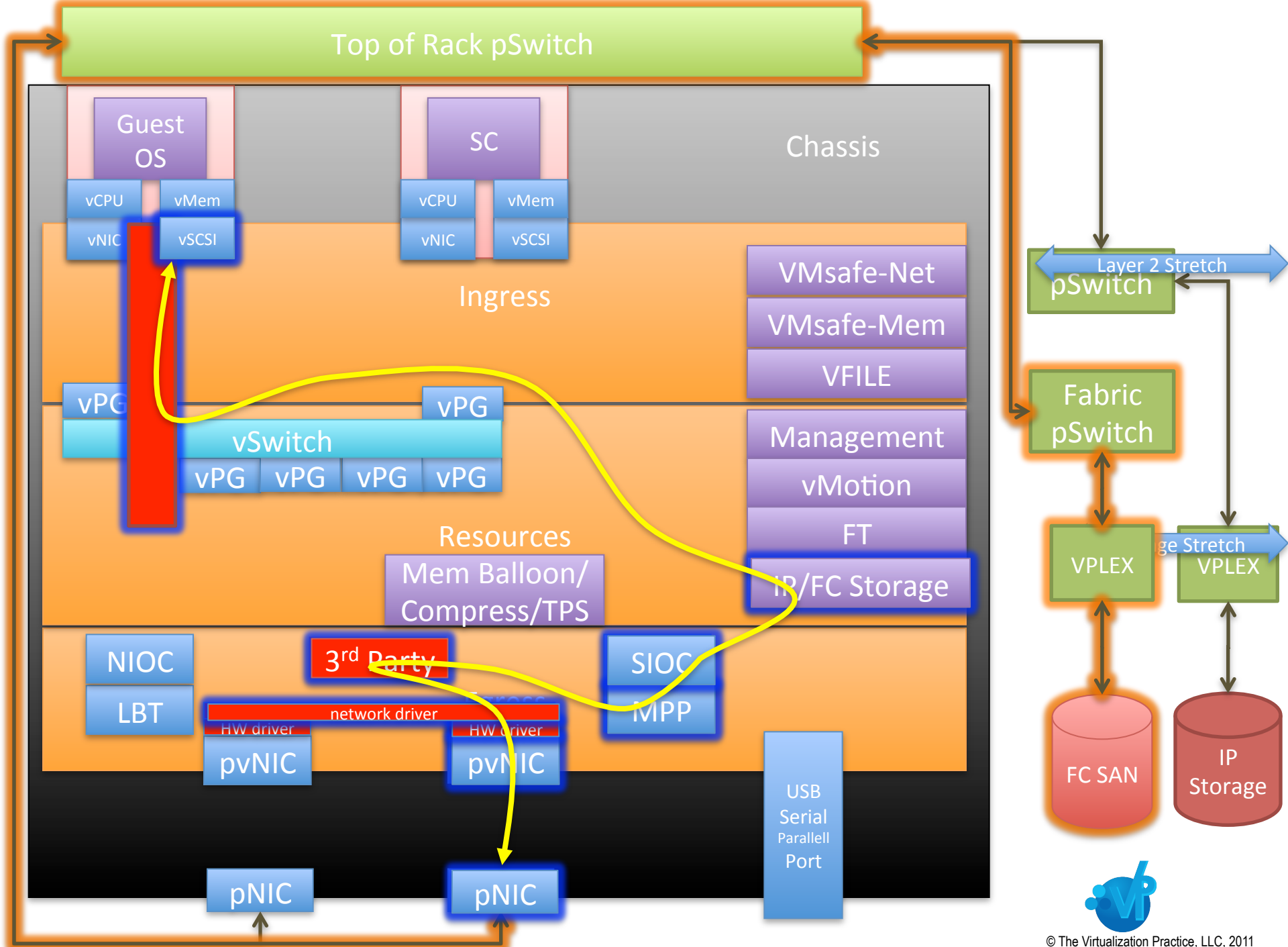

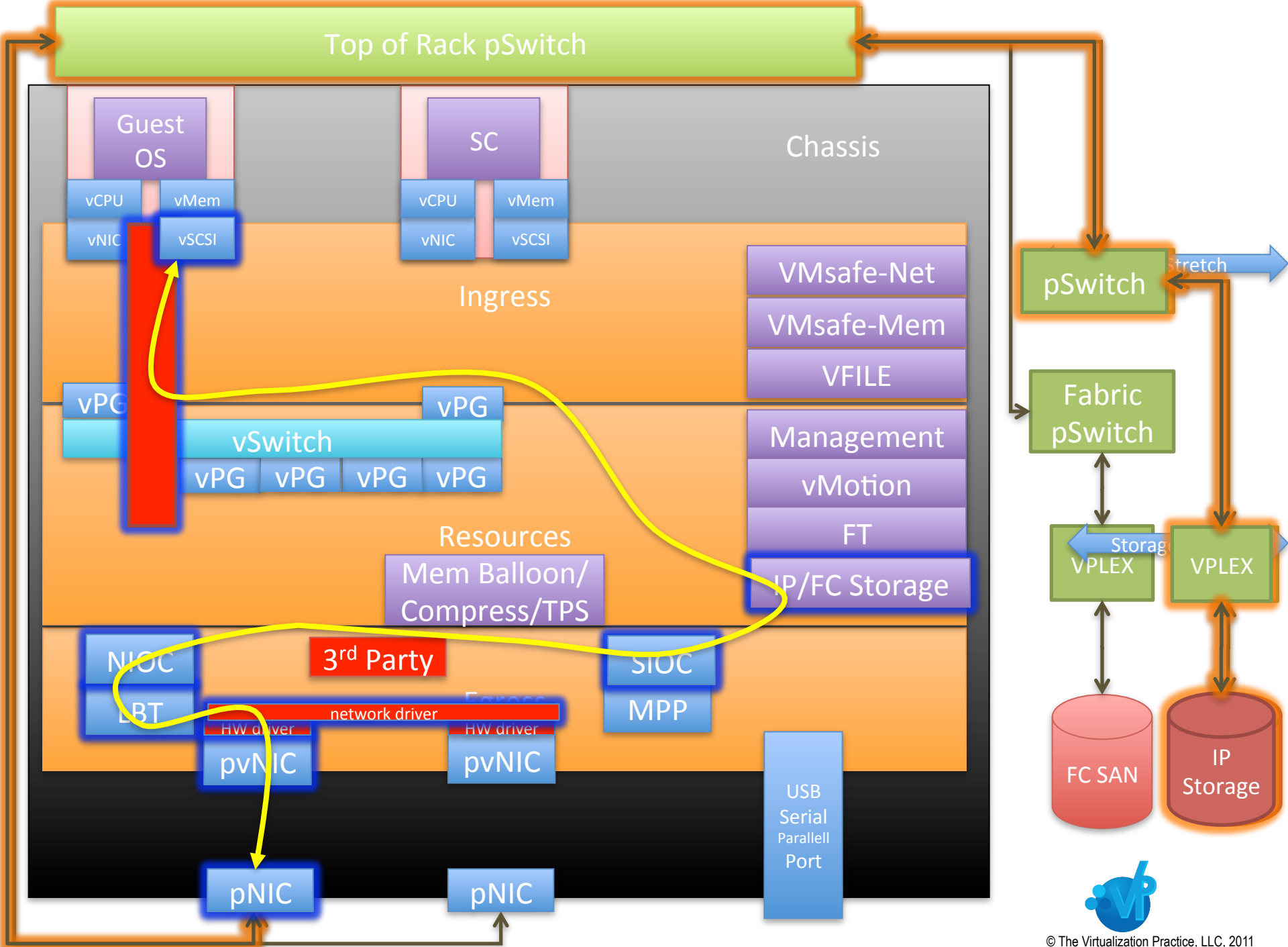

Top of Rack pSwitch

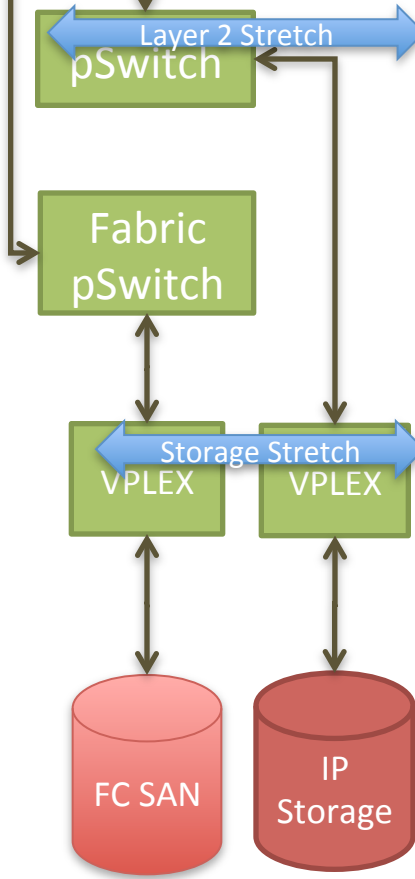
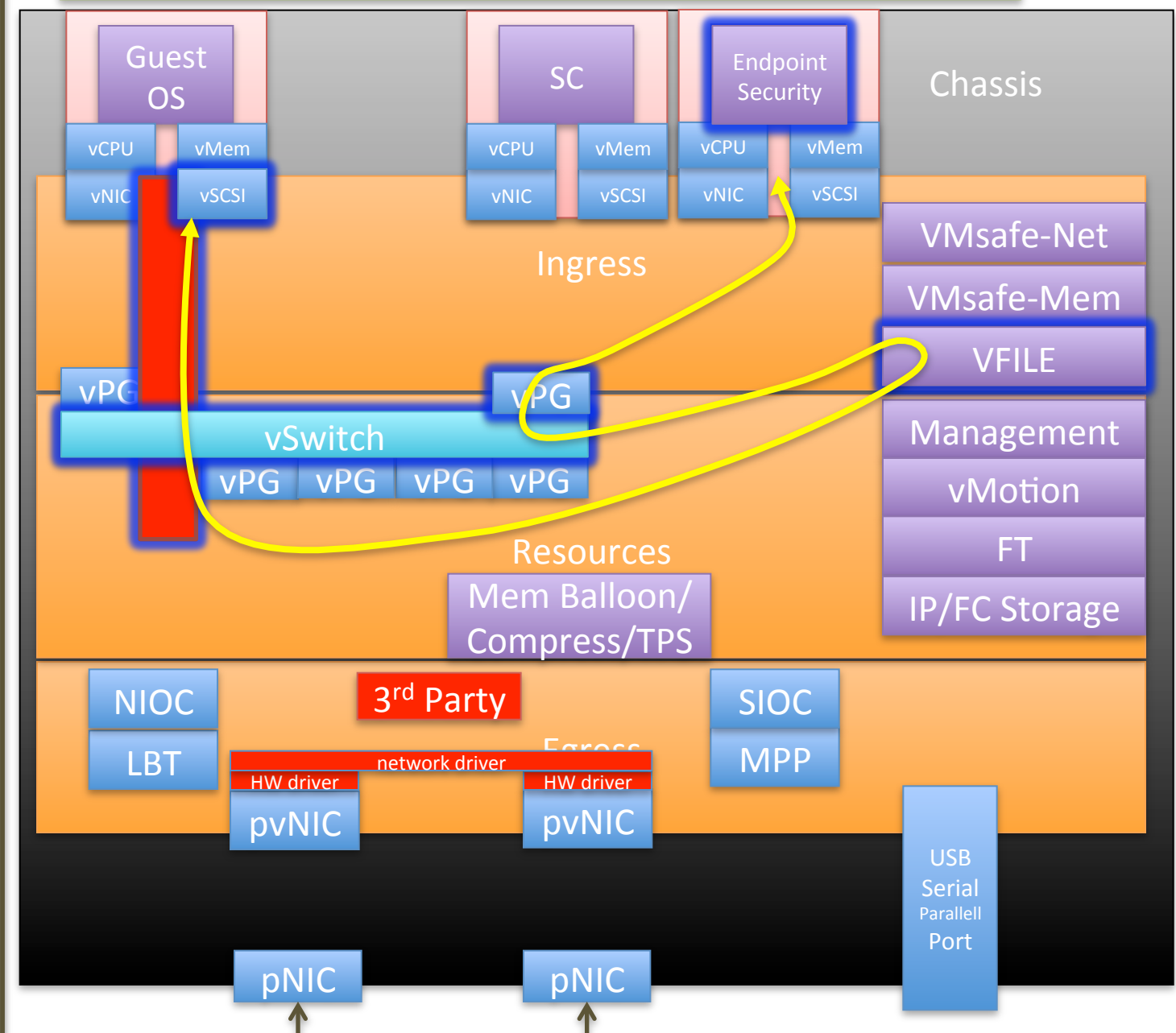

Top of Rack pSwitch

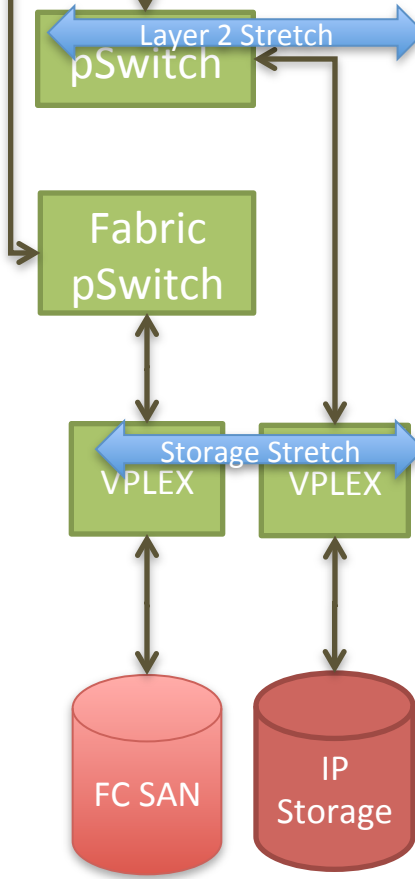
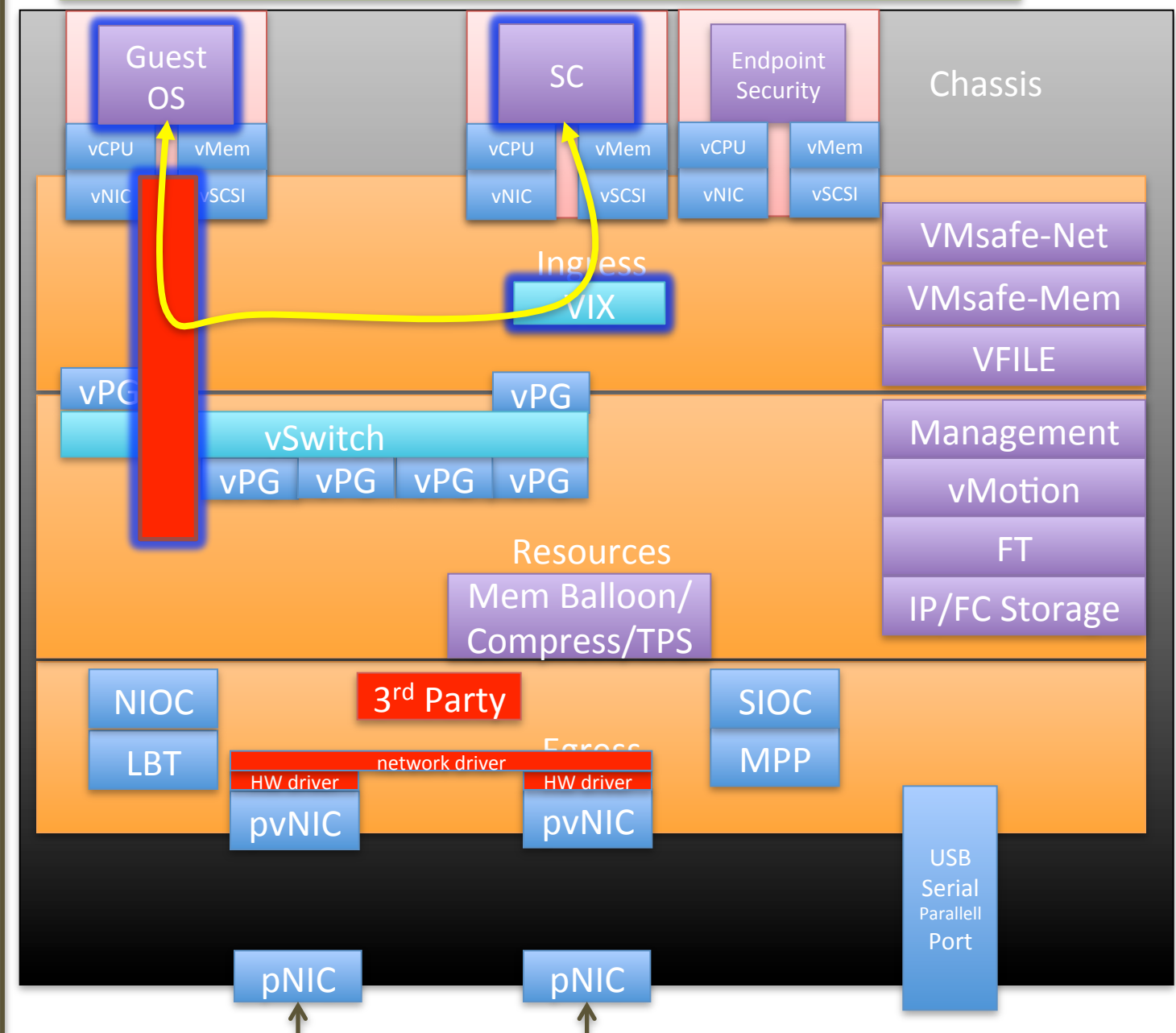

Top of Rack pSwitch

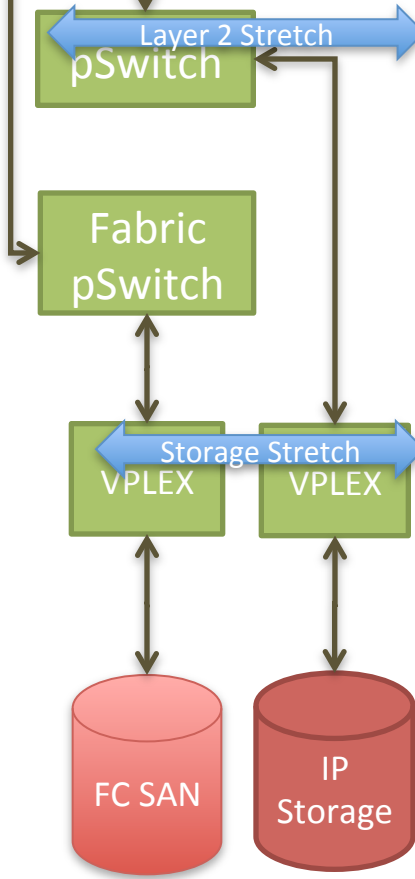
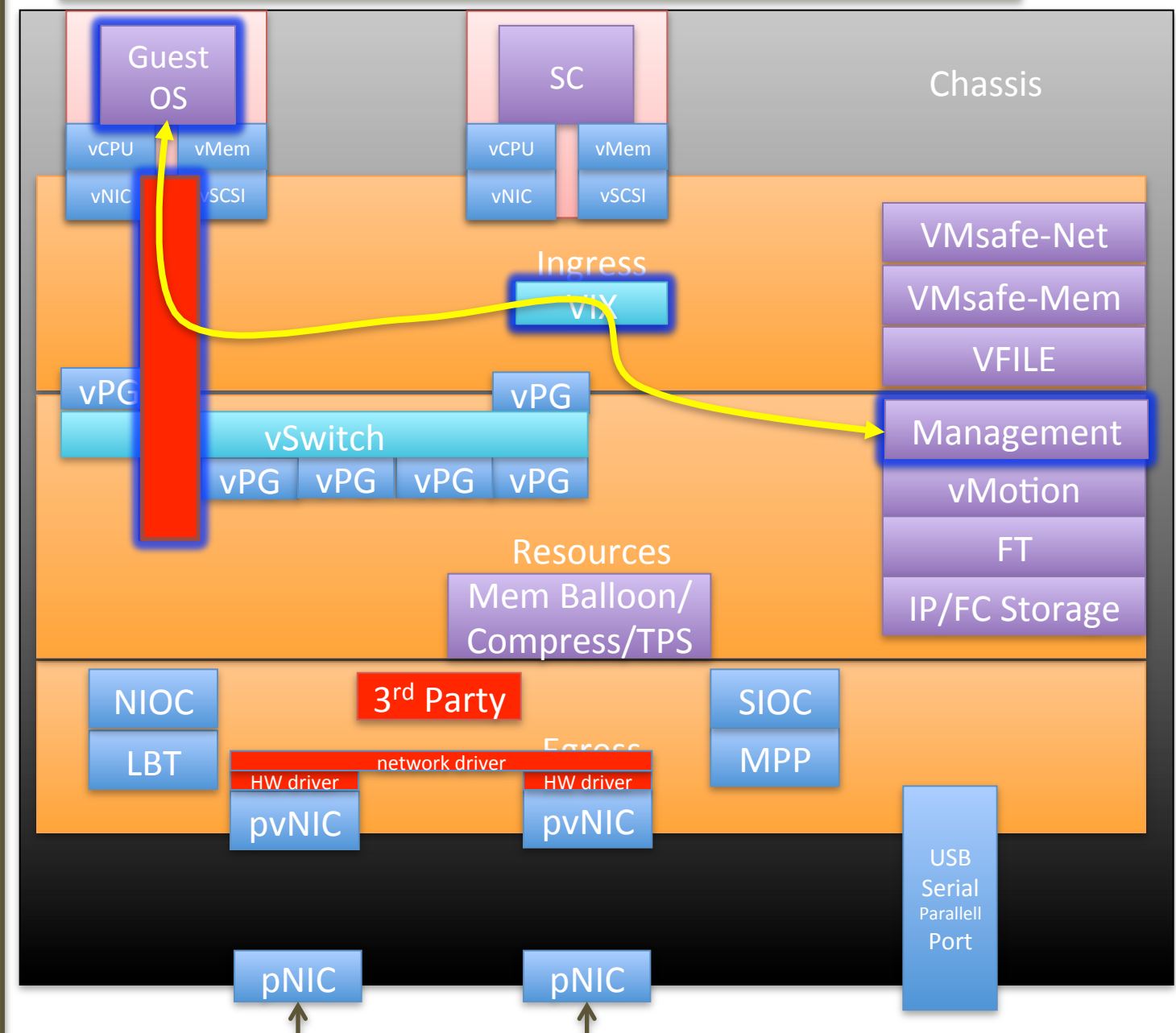

Top of Rack pSwitch

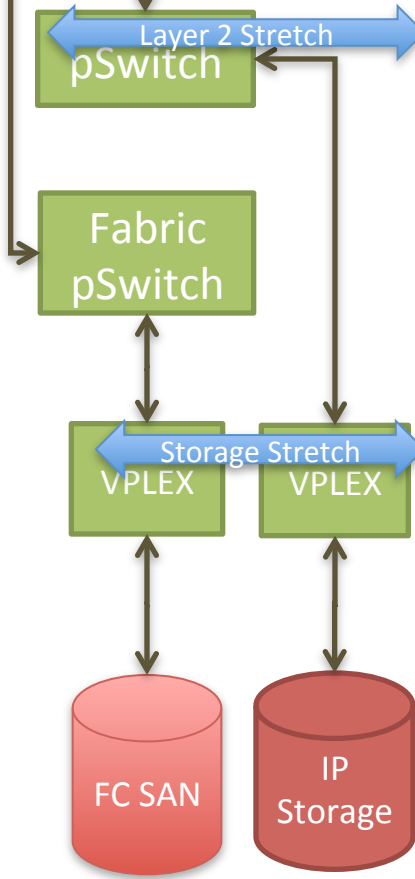
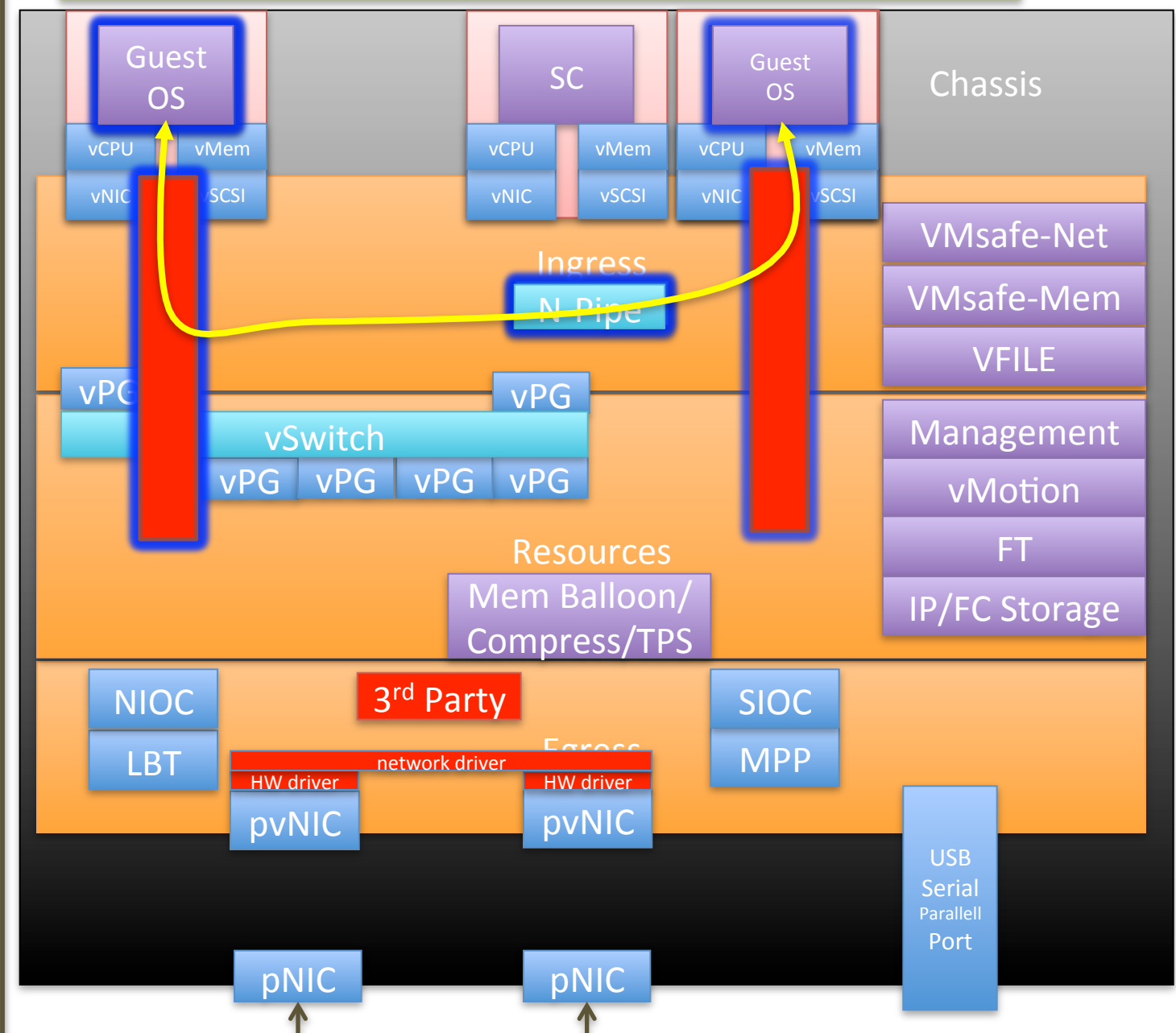

Top of Rack pSwitch

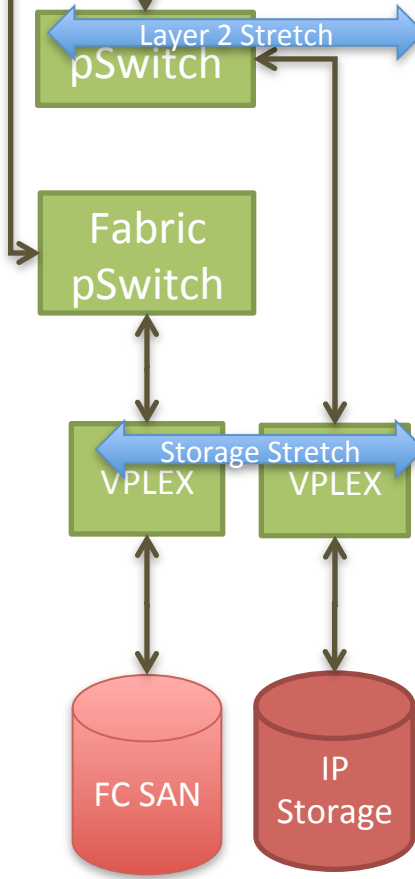
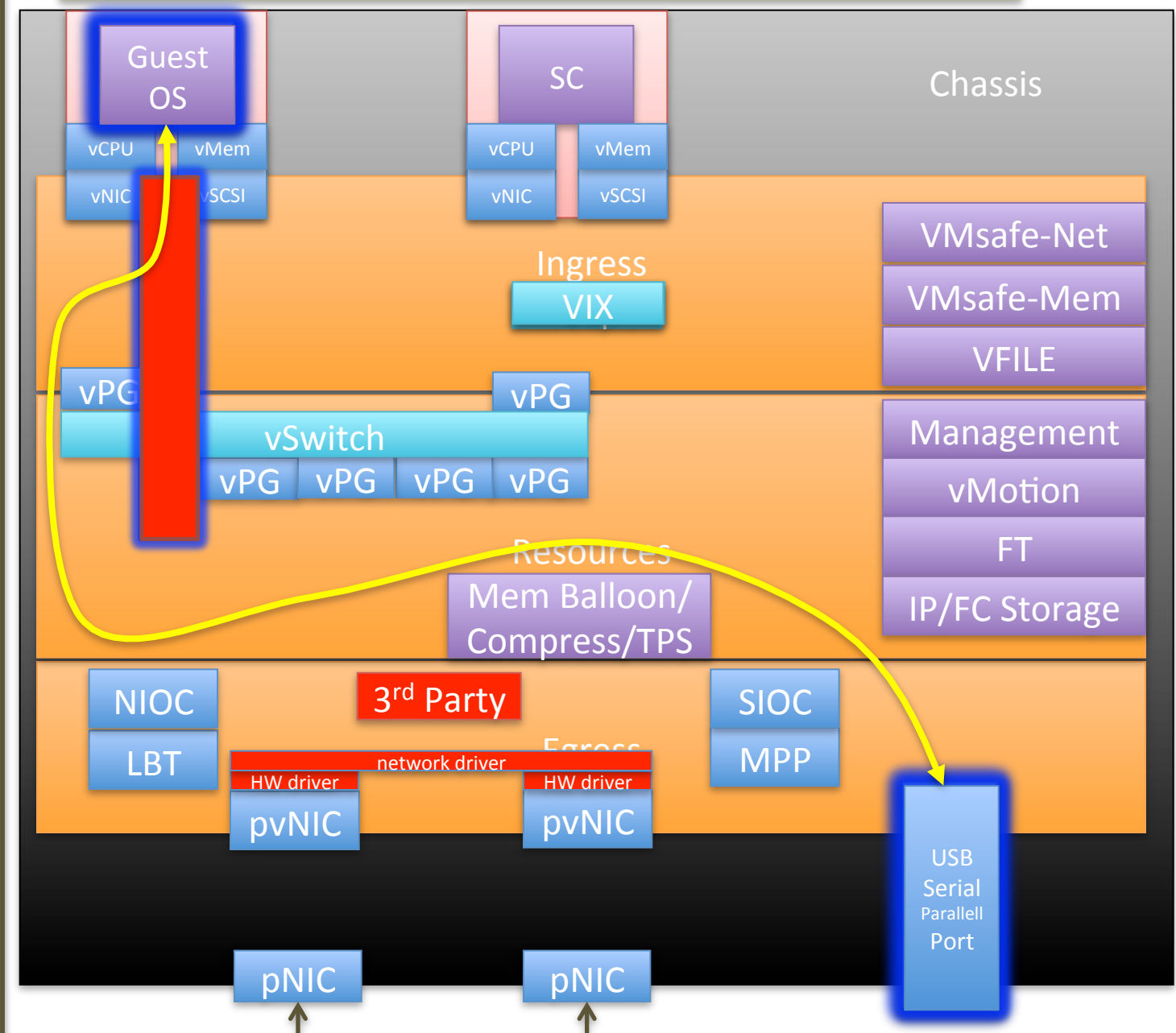

Top of Rack pSwitch

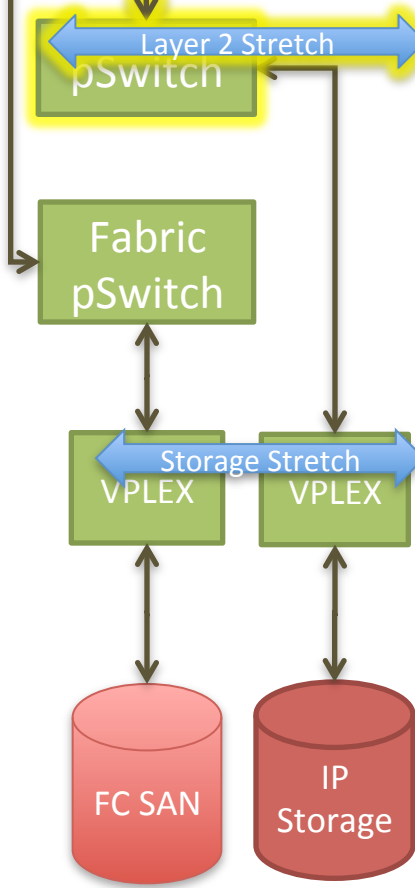
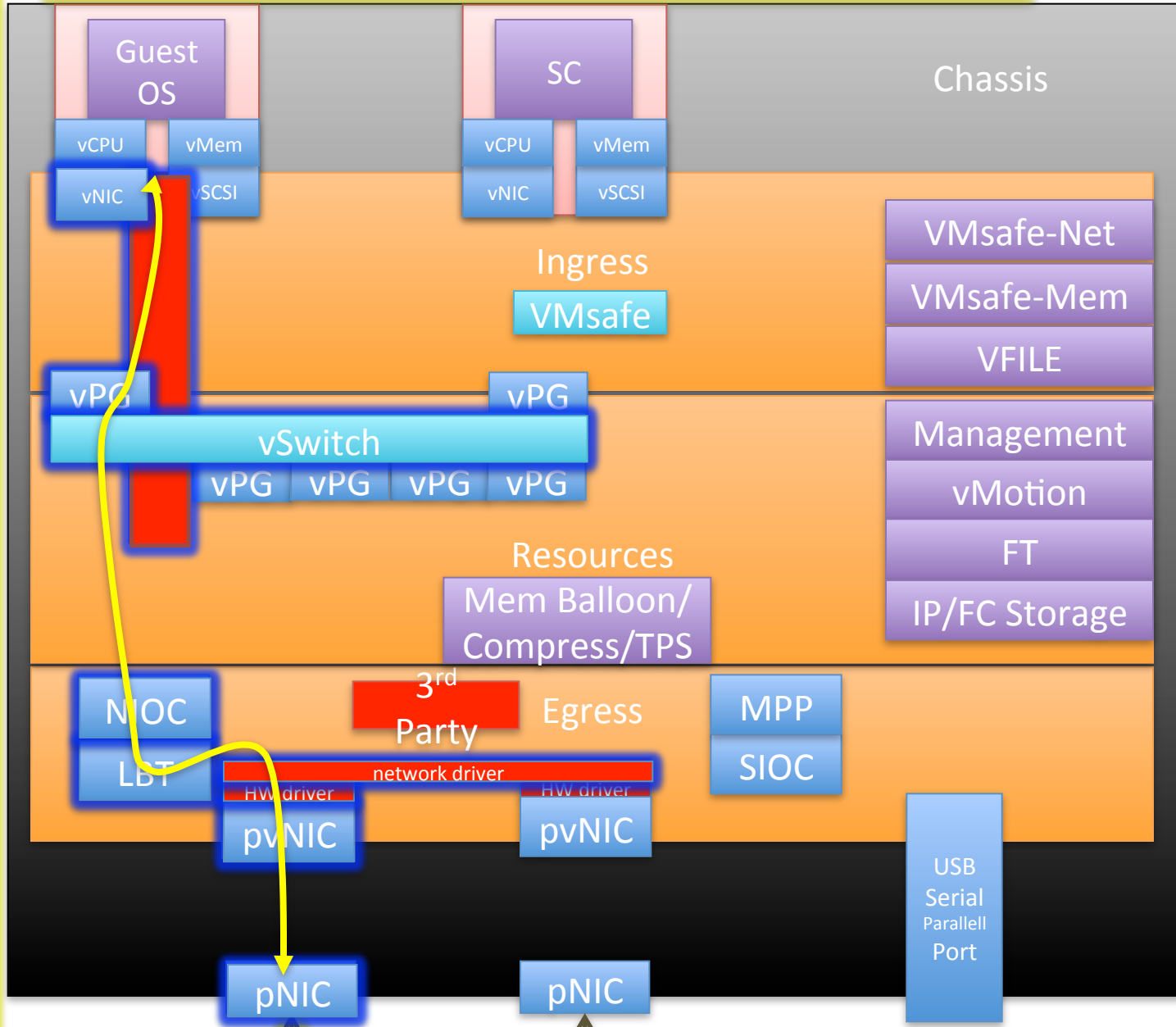

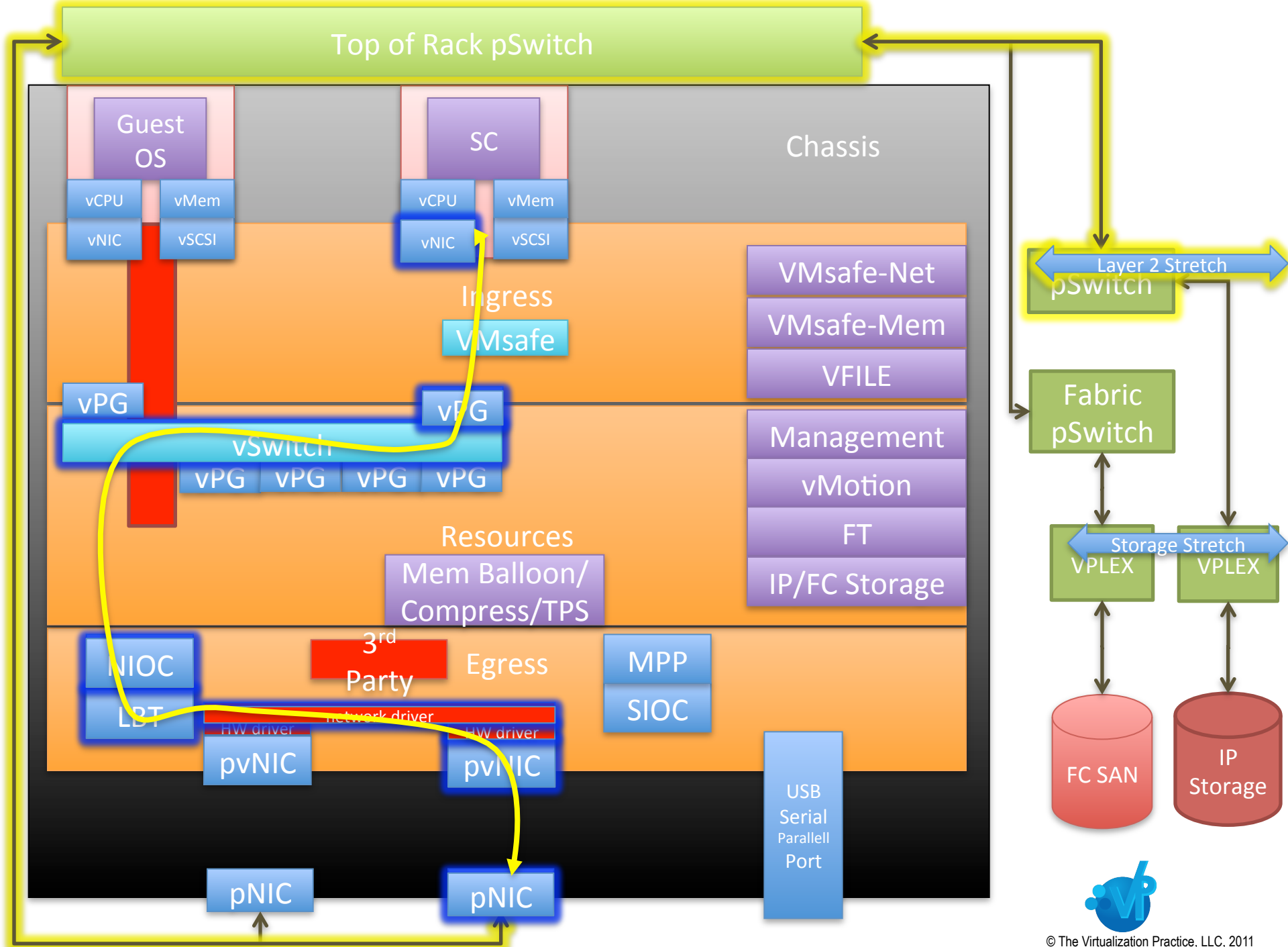

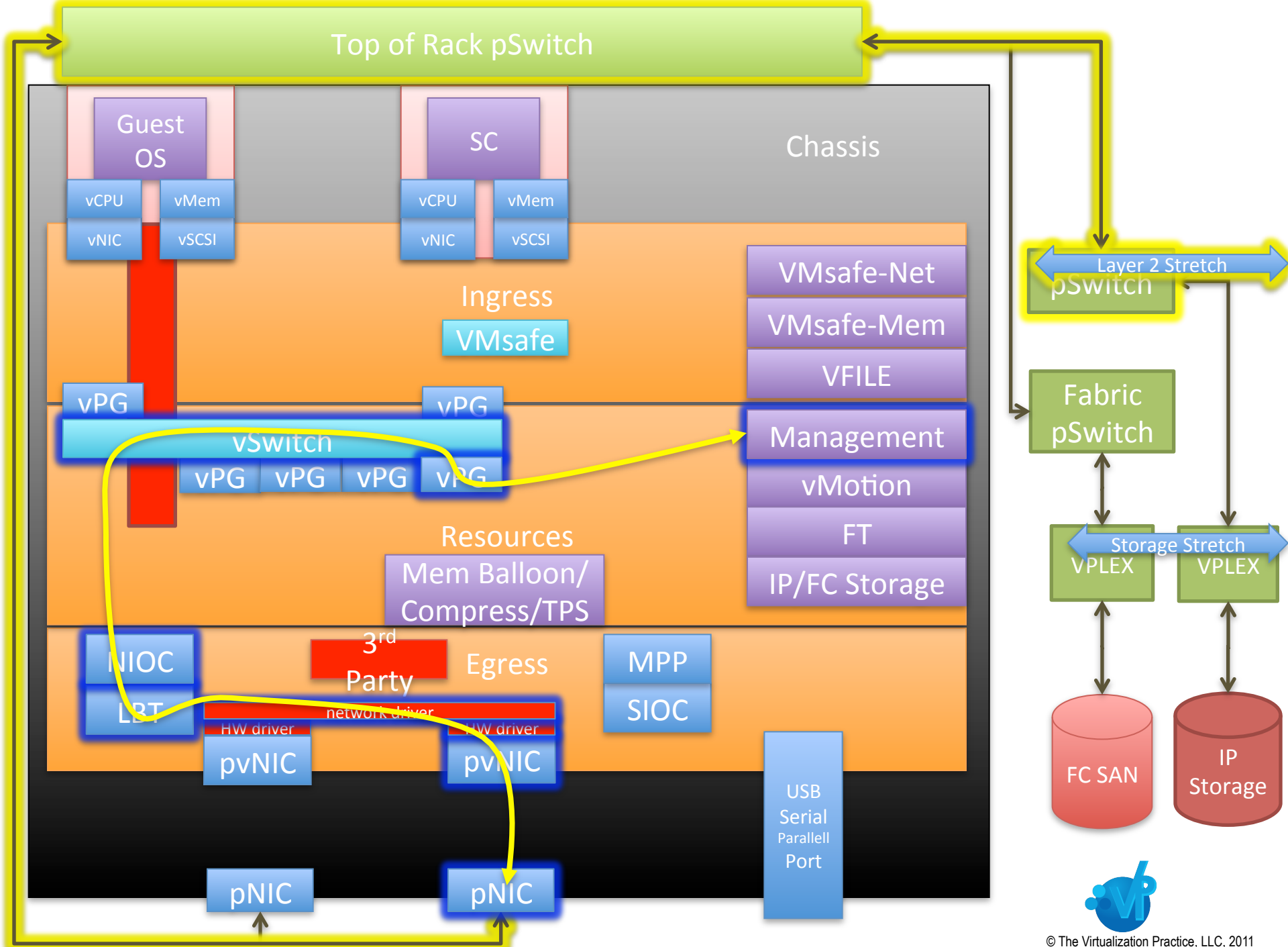

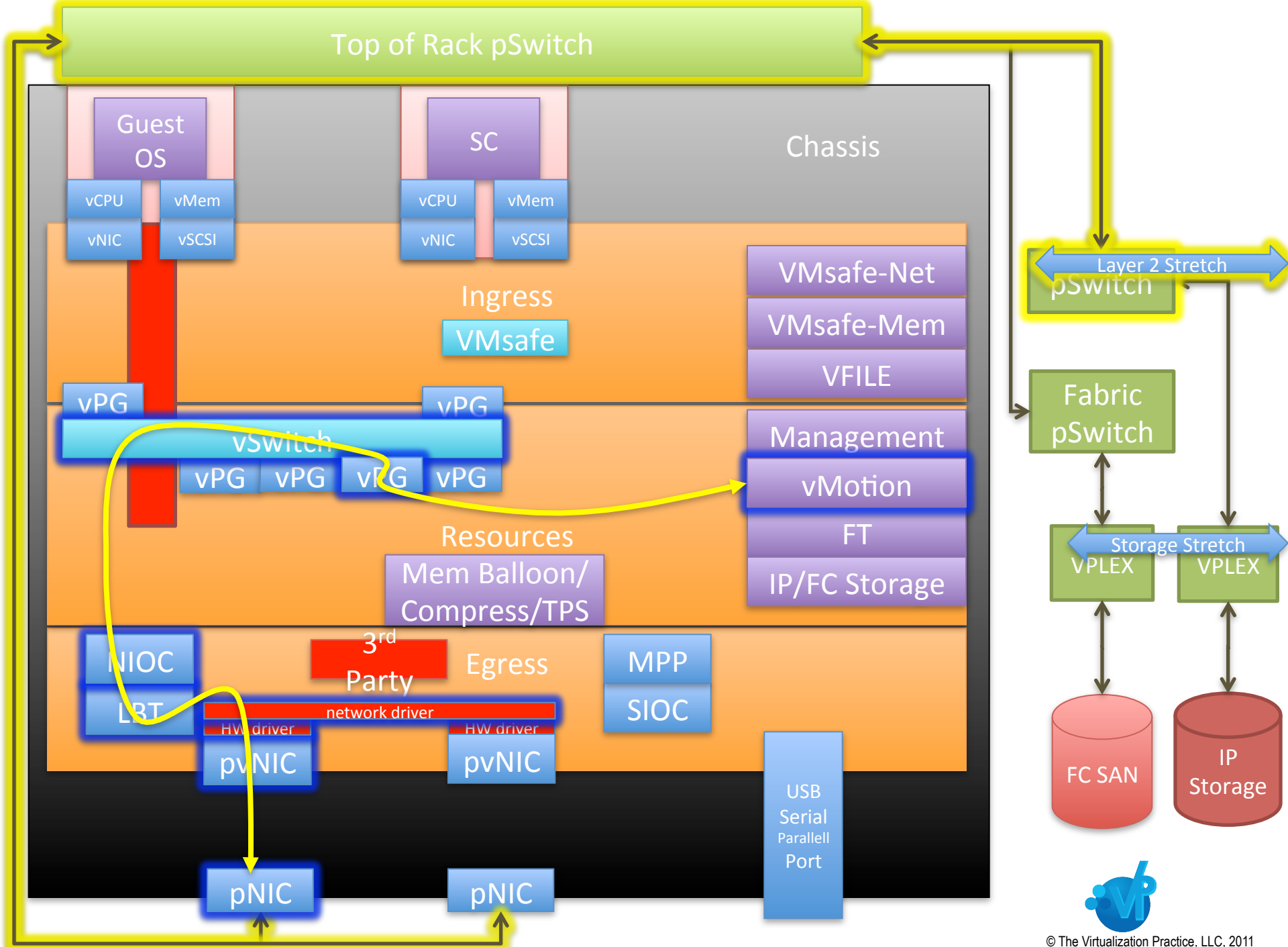

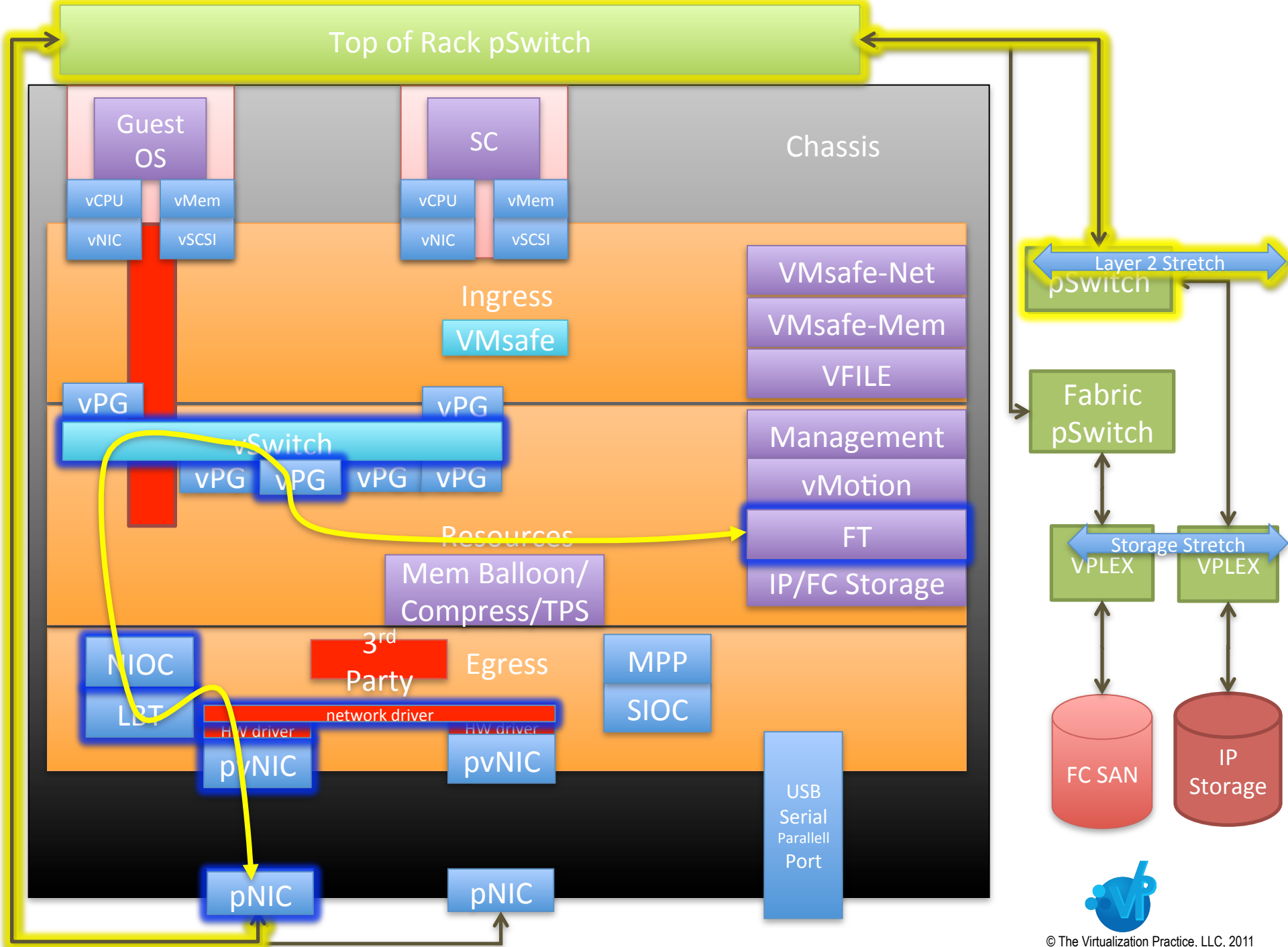

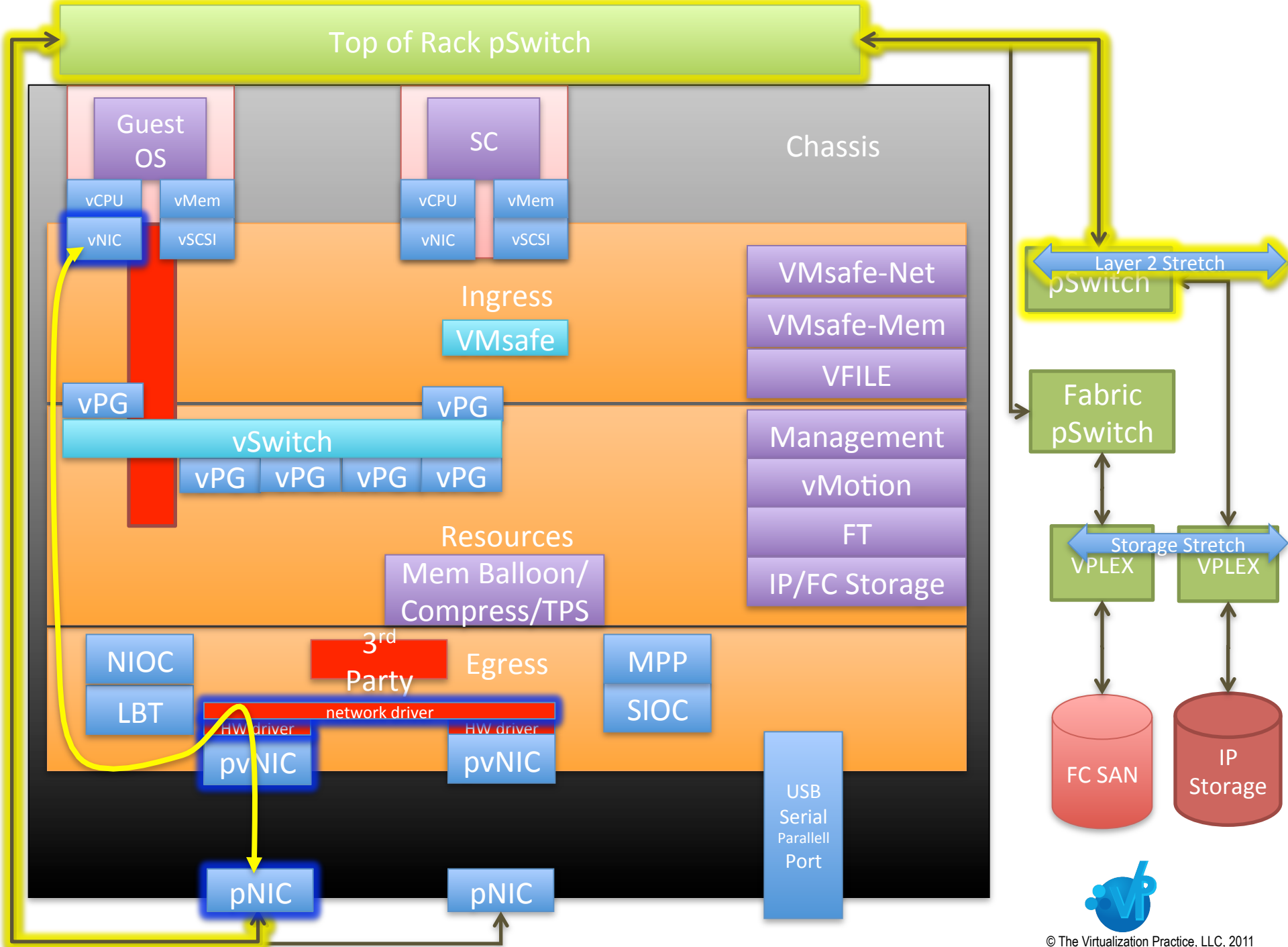

Top of Rack pSwitch

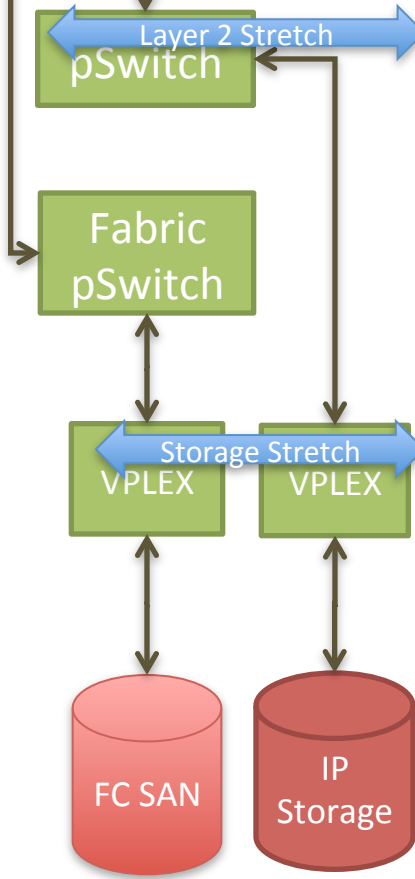
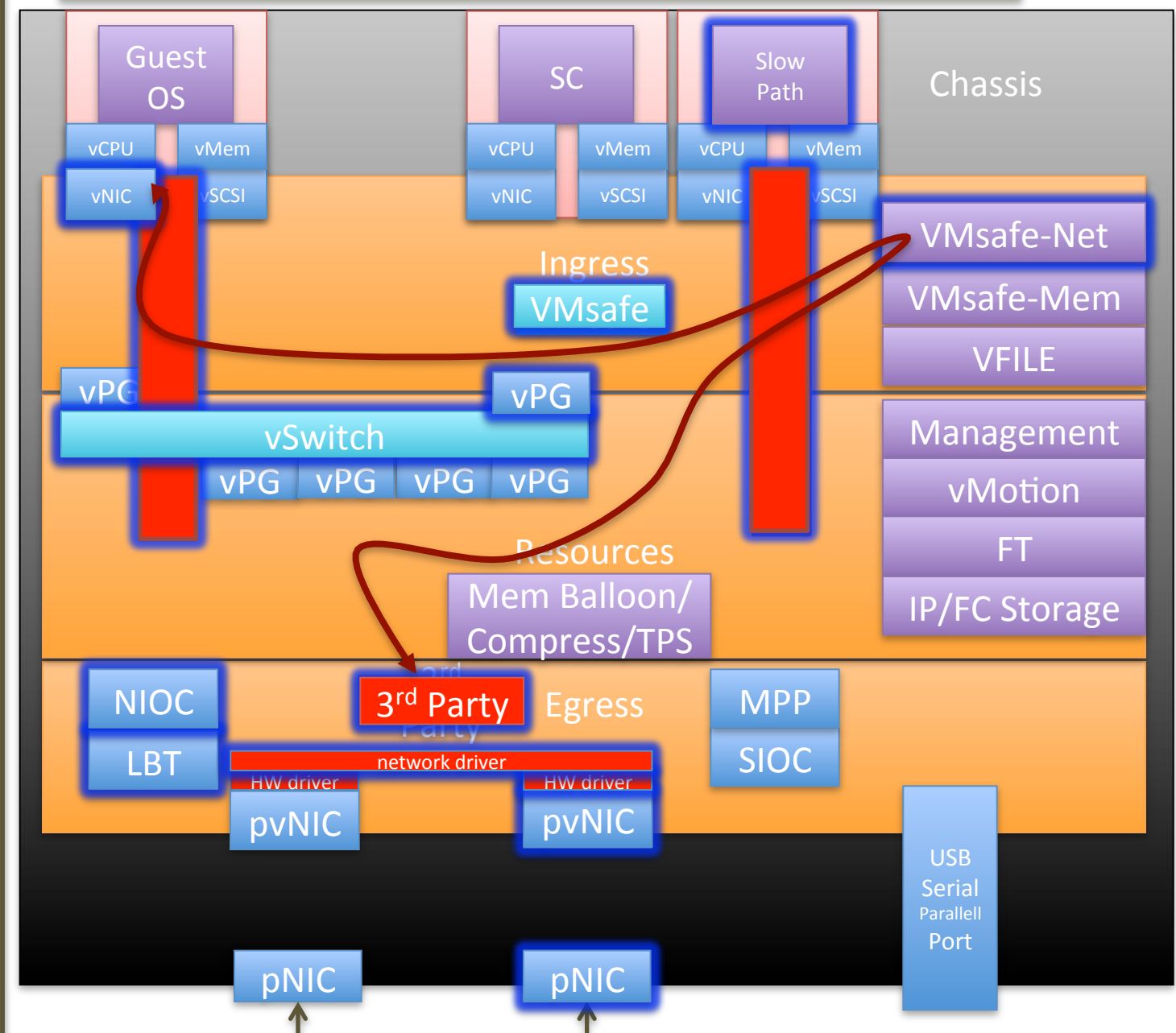

Top of Rack pSwitch

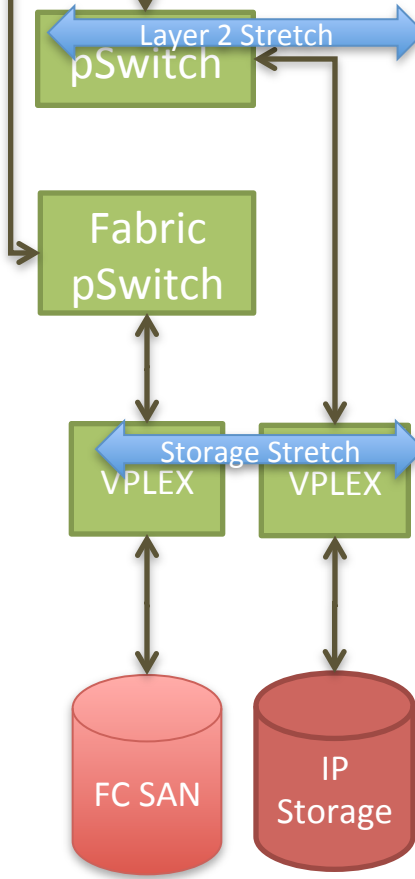
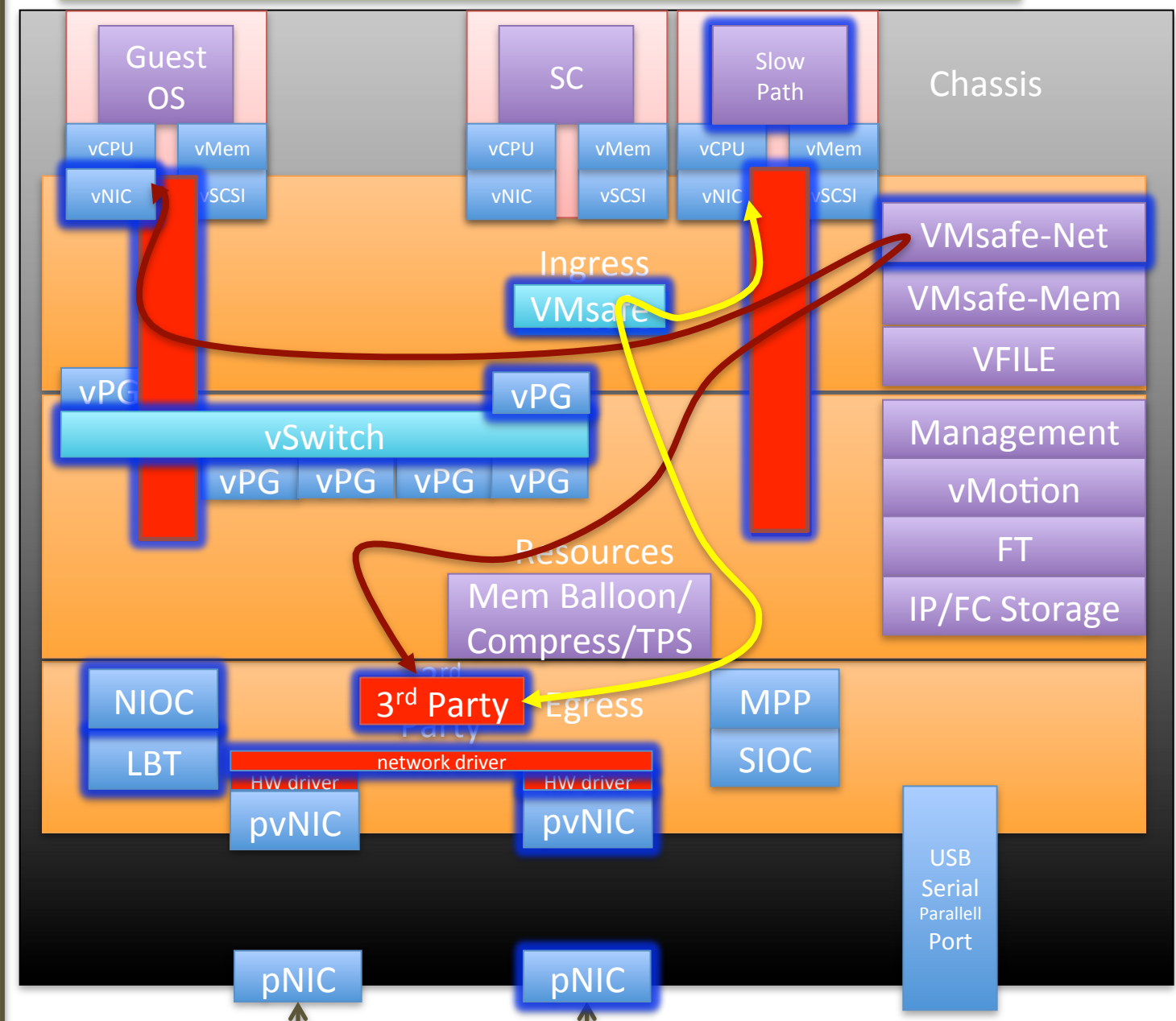

Top of Rack pSwitch

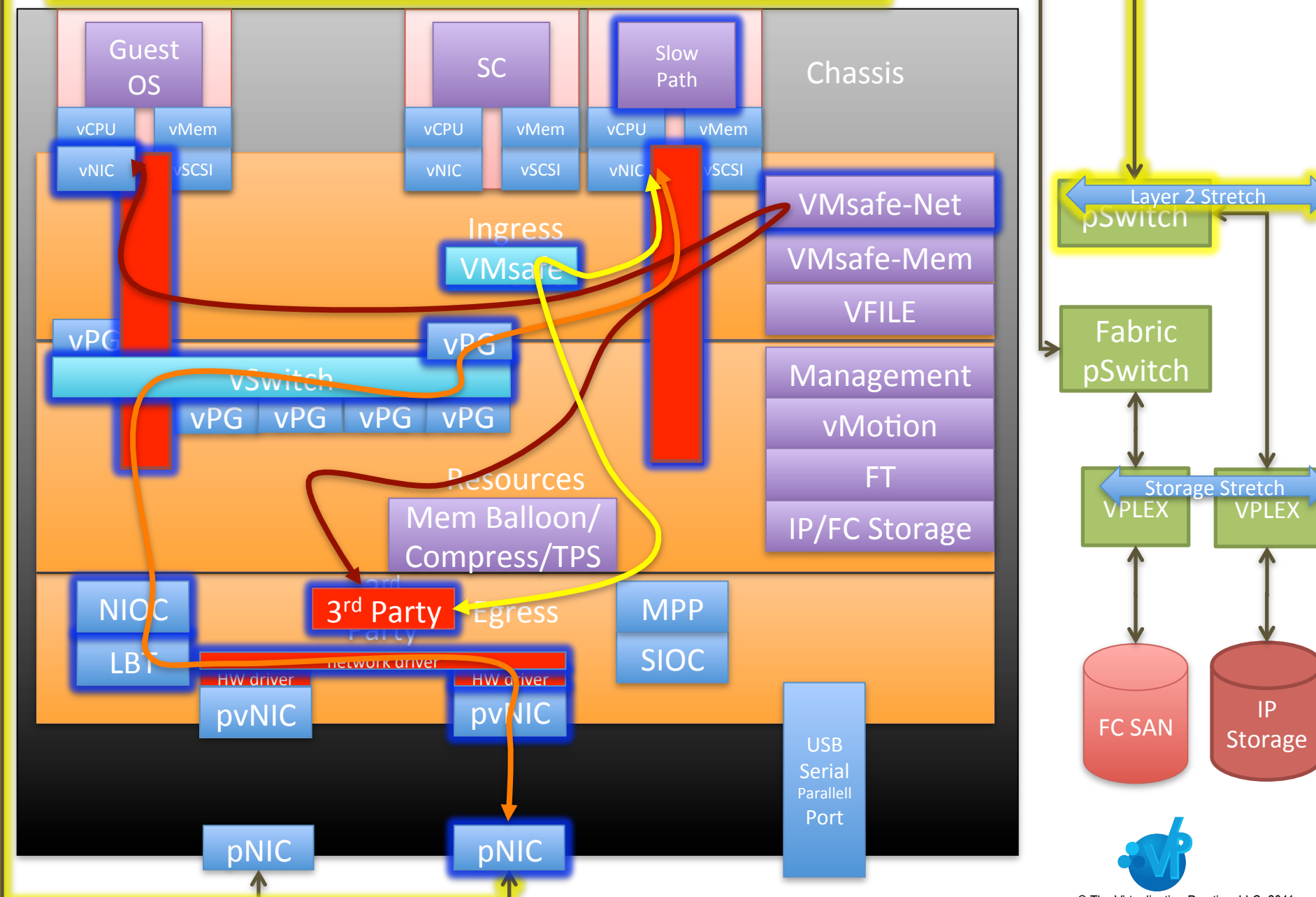

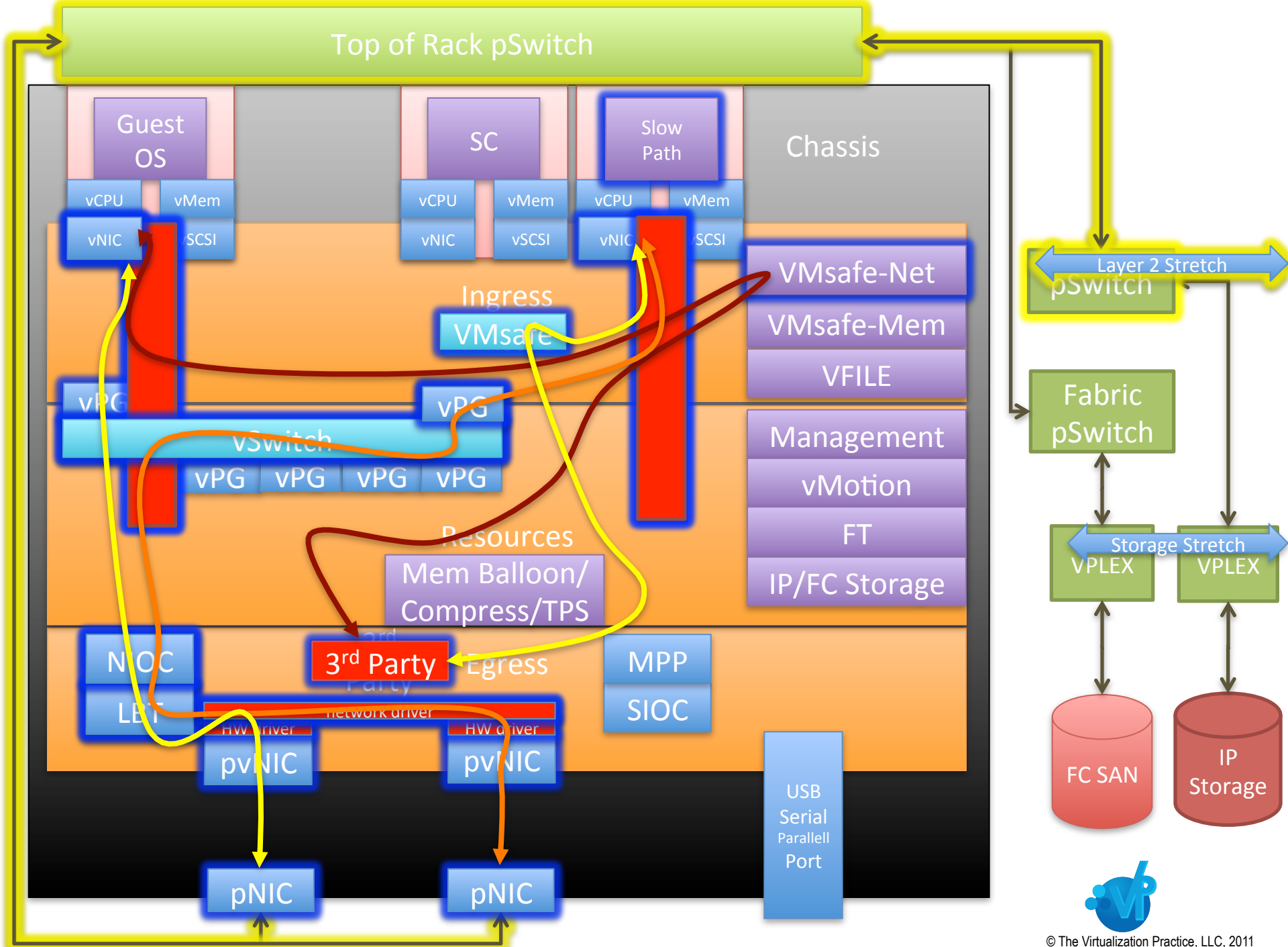

Top of Rack pSwitch

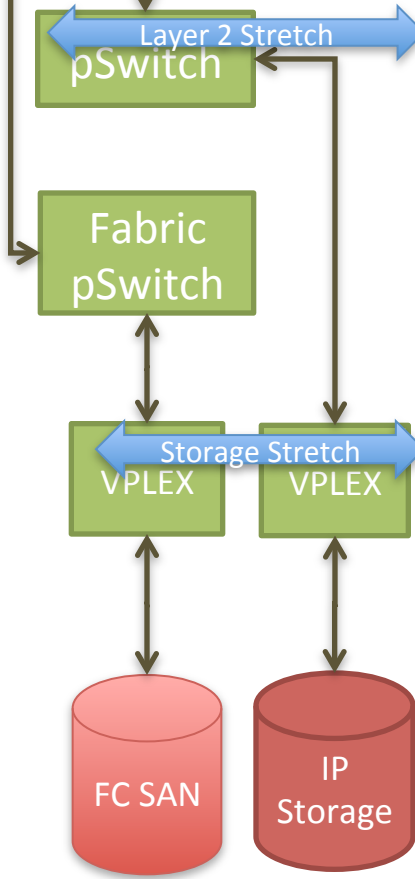
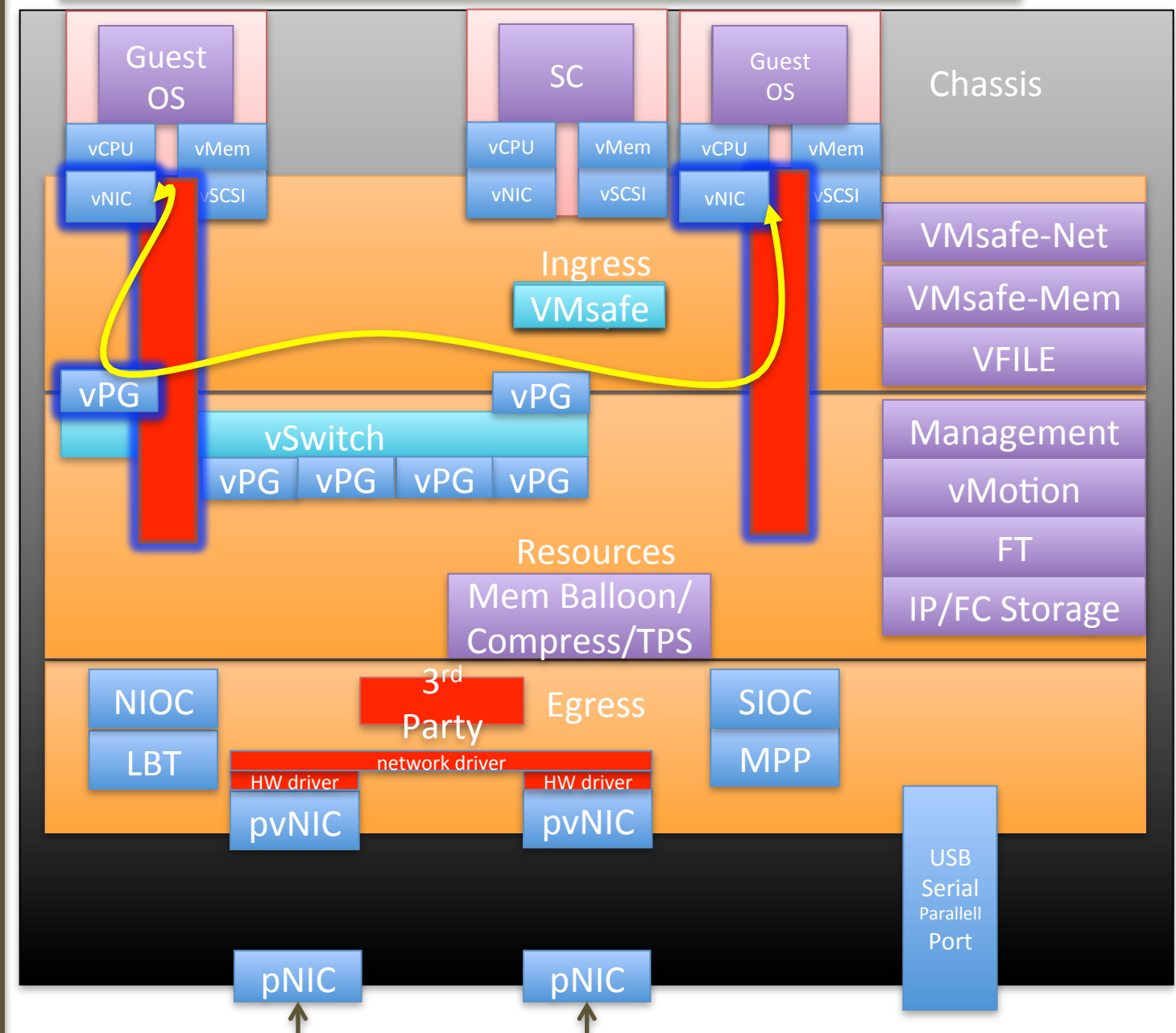

Top of Rack pSwitch

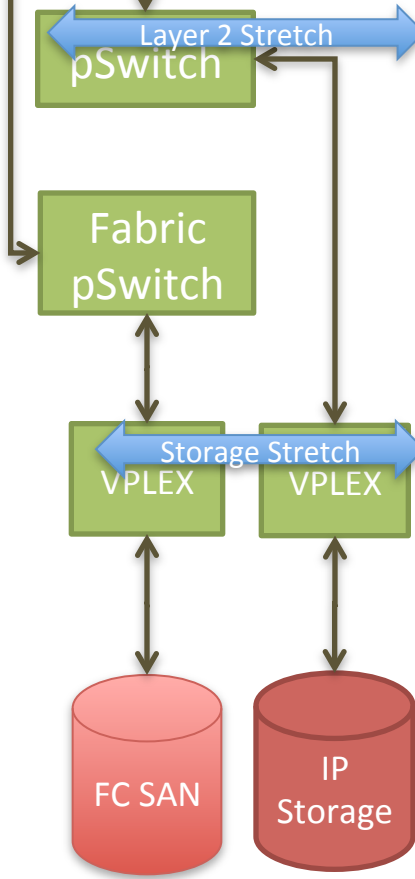
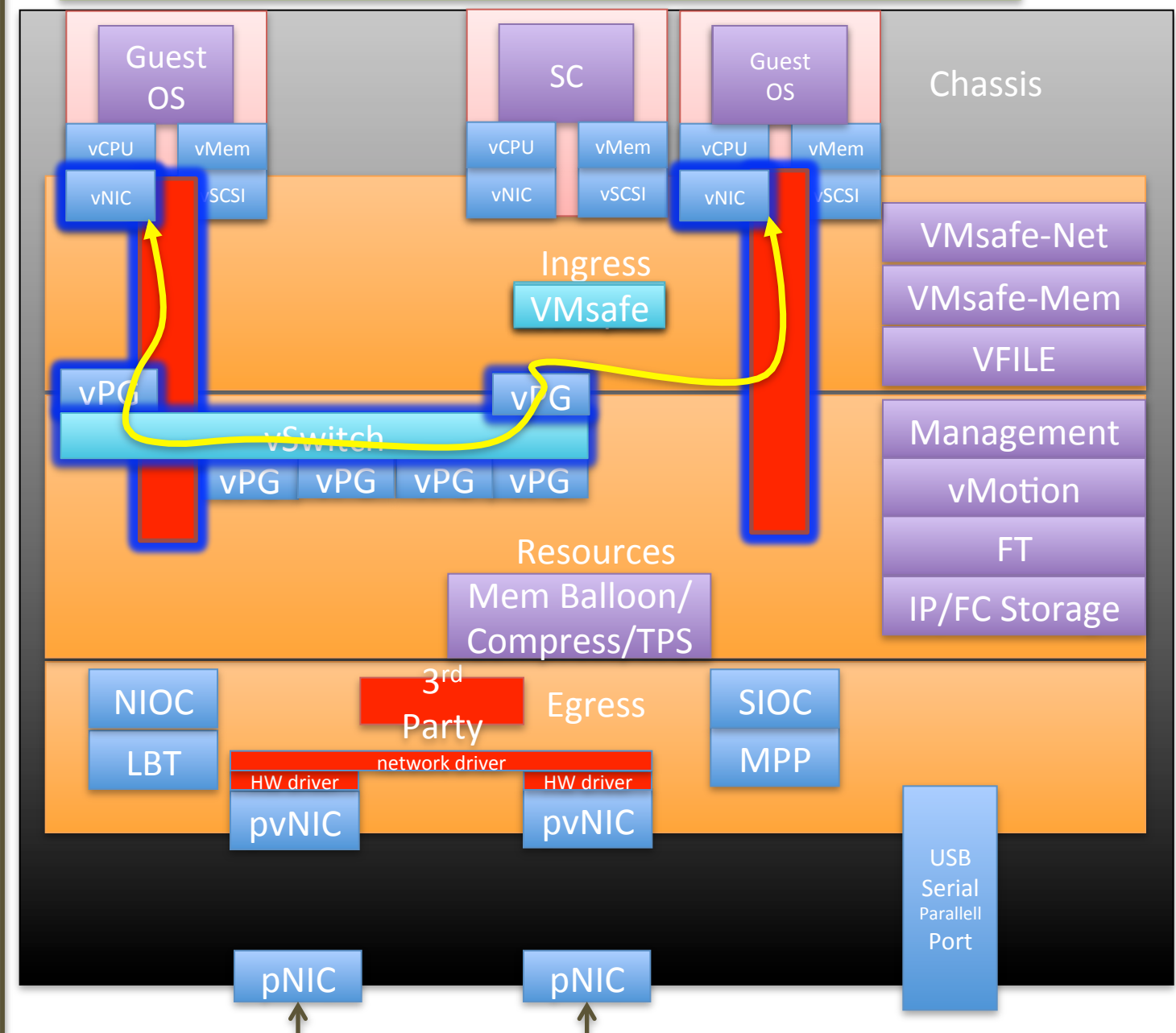

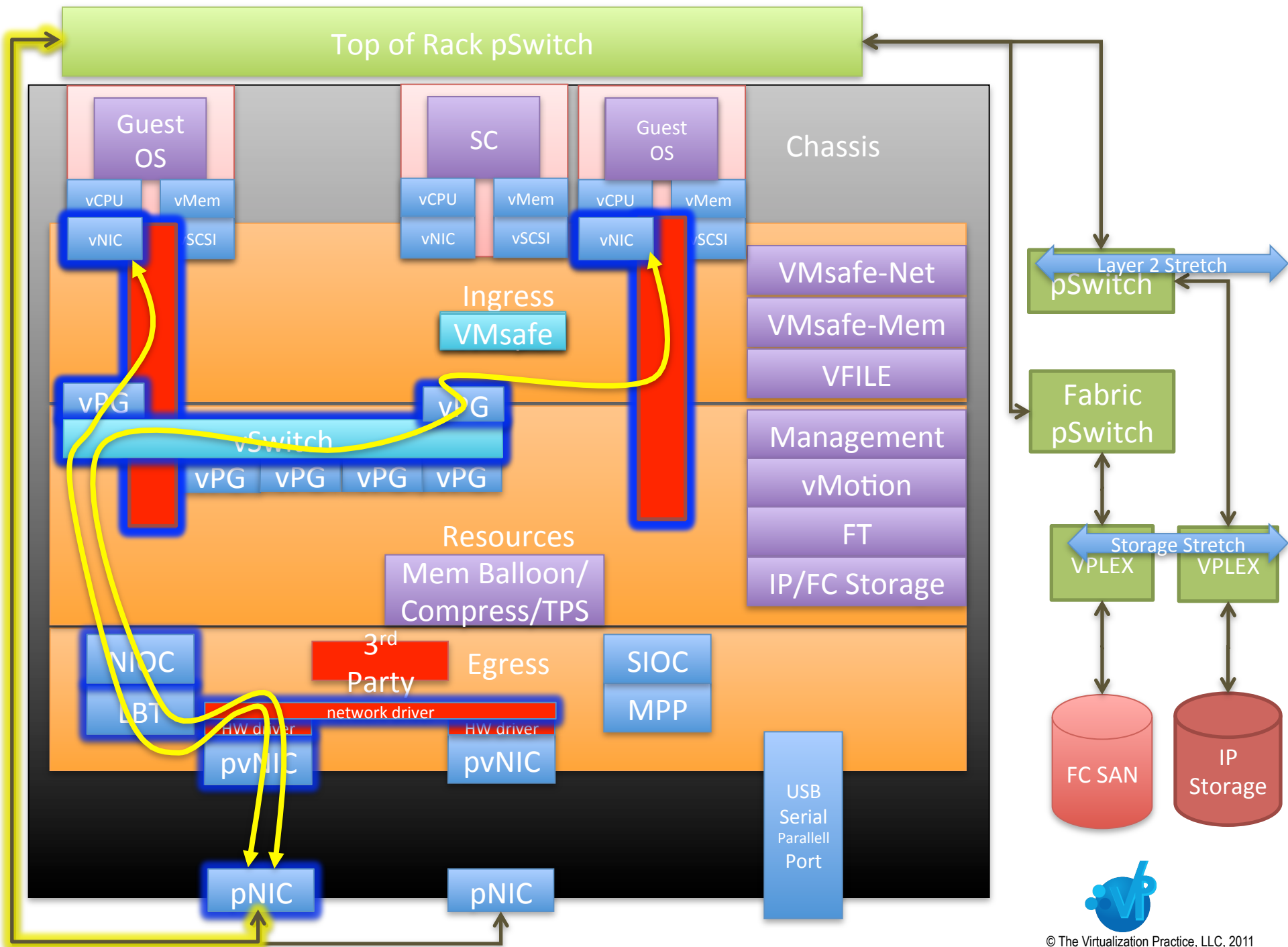

Top of Rack pSwitch

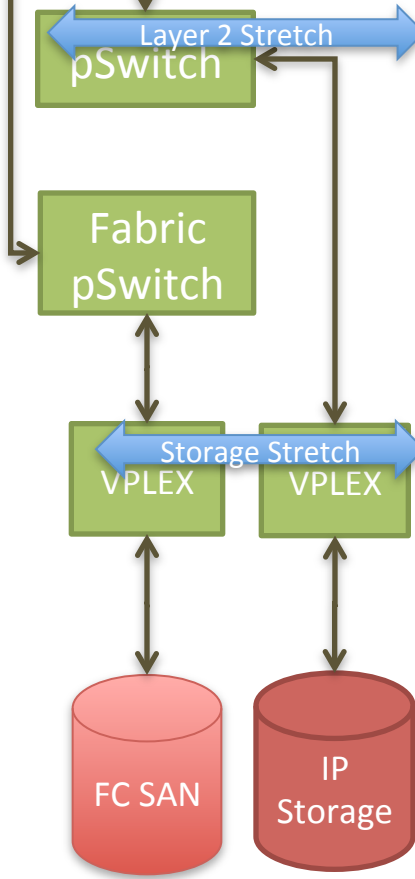
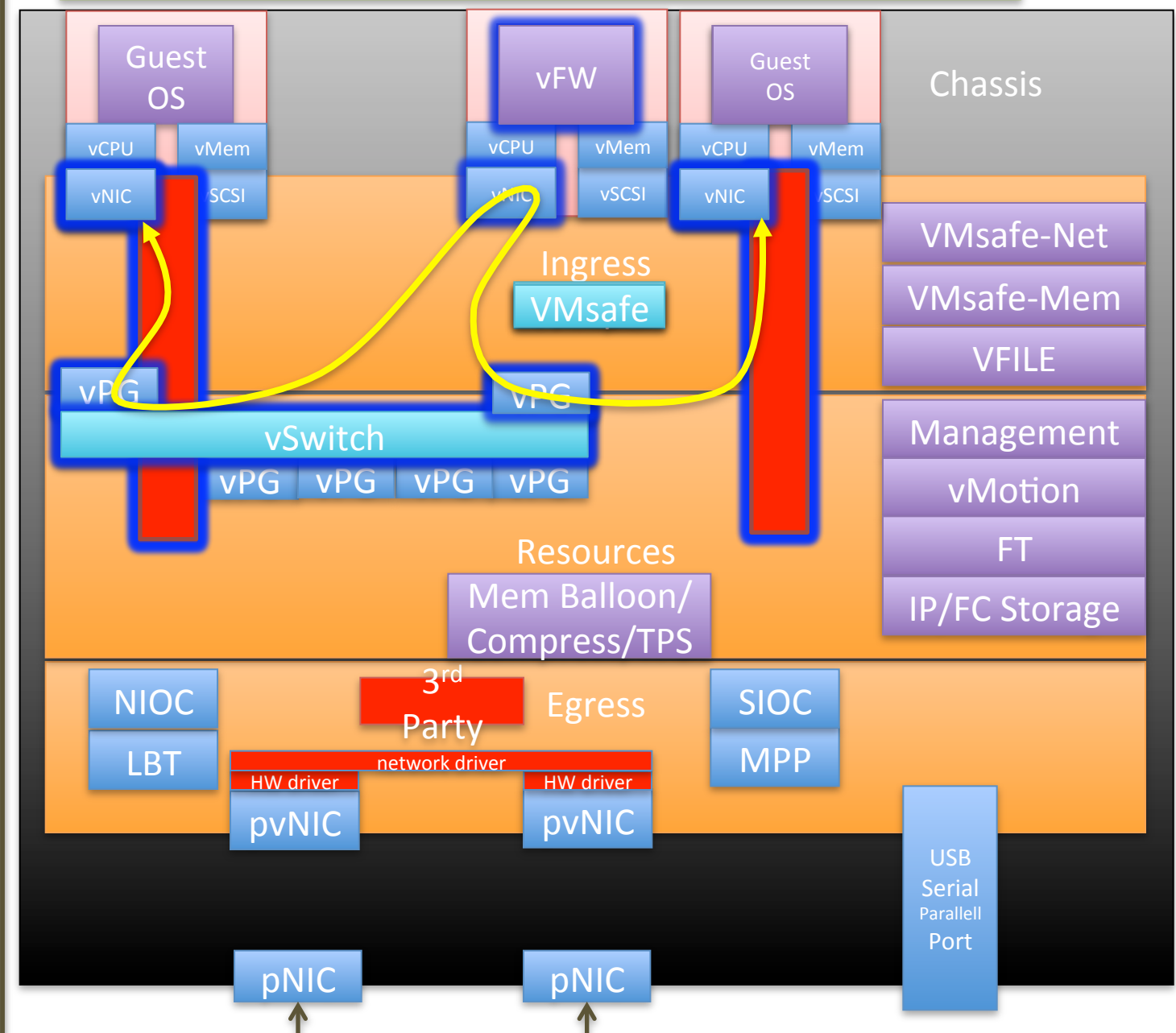

Top of Rack pSwitch

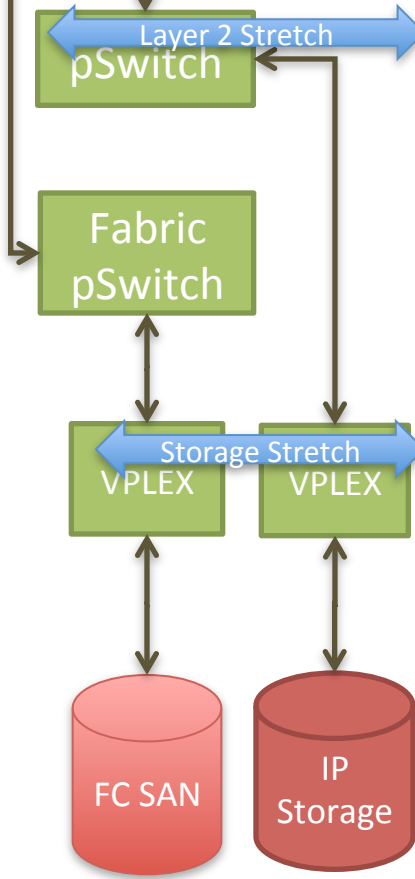
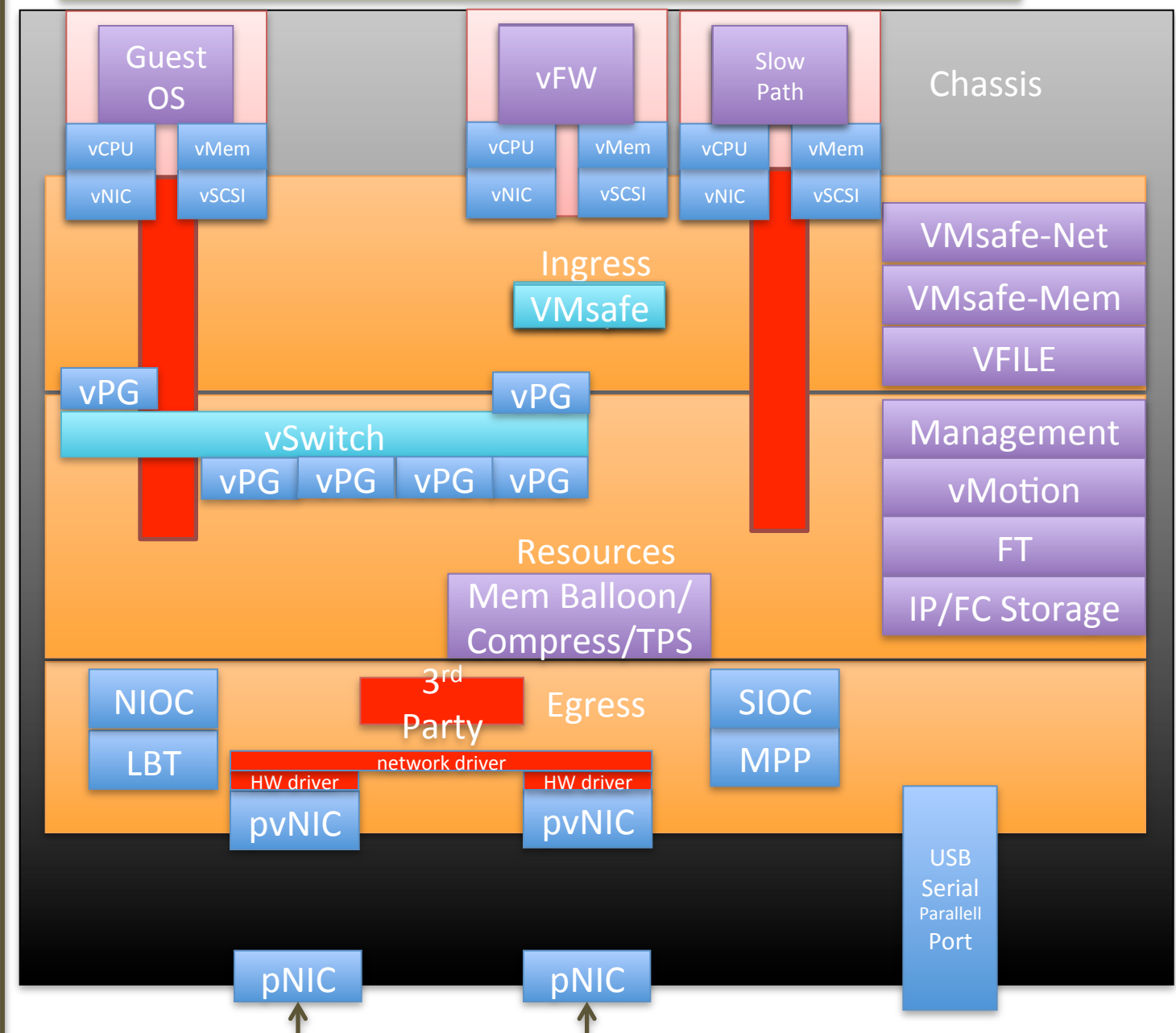

Where to go for More Information

The Virtualization Practice

<http://www.virtualizationpractice.com>

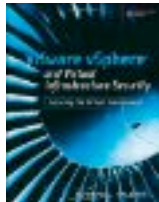

[VMware vSphere and Virtual Infrastructure Security: Securing the Virtual Environment.](#) Prentice Hall
(2009-07-02) 0137158009

Top Security Links

http://www.virtualizationpractice.com/blog/?page_id=4931

Virtualization Security Podcast (on iTunes)



QUESTIONS?

